

Air 1

Commander for wireless flash shooting
Four Third / Micro Four Third

INSTRUCTION MANUAL



Changes or modifications not expressly approved by the party responsible for compliance could void the user's authority to operate the equipment.

This device complies with Part 15 of the FCC Rules. Operation is subject to the following two conditions: (1) this device may not cause harmful interference, and (2) this device must accept any interference received, including interference that may cause undesired operation.

Thank you for purchasing a Nissin product

Before using this commander unit, read this instruction manual and the instruction manuals of your camera and NAS Flash to familiarize yourself with the operations.

The commander Air 1 (type Four Third / Micro Four Third) is a transmitter for wireless flash shooting. It can control up to 3 groups of NAS (Nissin Air System) flash (type Four Third / Micro Four Third) that have a wireless multiple flash shooting function using NAS (radio transmission). Please note that Air 1 Four Third and Micro Four Third are not usable with other branded cameras for TTL operation.

Compatible cameras

Please refer Nissin's compatibility chart shown at its home page for details and recent updates: <http://www.nissin-japan.com> or <http://www.nissindigital.com>



Nissin Air System (NAS) is designed for Nissin flash and Nissin commander.

-  2.4 GHz Transmission
- Transmission distance, approx. 30m (98.4 ft.)
- Metal/ Wire/ Wall/ another 2.4 GHz radio may reduce the NAS transmission distance
- The Nissin commander attached to the camera is called master unit. Di700A/i60A will be switched to Radio Transmission Mode (2.4GHz transmission) once connecting to NAS Commander, all functions will be controlled through NAS Commander. Otherwise, Optical Transmission mode will be enabled by default.

SAFETY INSTRUCTIONS

These safety instructions refer to important information on how to use this product safely and properly. Please read the following instructions before using the product.



CAUTIONS

This sign refers to conditions which may cause damage or defect.

- Do not touch the inside parts from the opening when the unit was dropped or broken.
- Place the batteries correctly in position. Placing the batteries in wrong polarity may cause leakage, exothermic heat or explosion.
- Do not leave or store the commander unit in the temperature over 40°C/ 104°F, such as in the automobile.
- The commander unit is not water resistance. Keep the unit away from rain, snow and humidity.
- Do not use benzene, thinner or other alcoholic agents to clean the unit.
- Do not use this commander unit with cameras which are not recommended in the compatibility list at official website, otherwise it may damage the camera's circuitry.
- Remove the batteries when not in use for a longer period of time.
- Do not have a heavy impact to the commander unit, nor throw it onto a hard surface floor.

Names of the Components

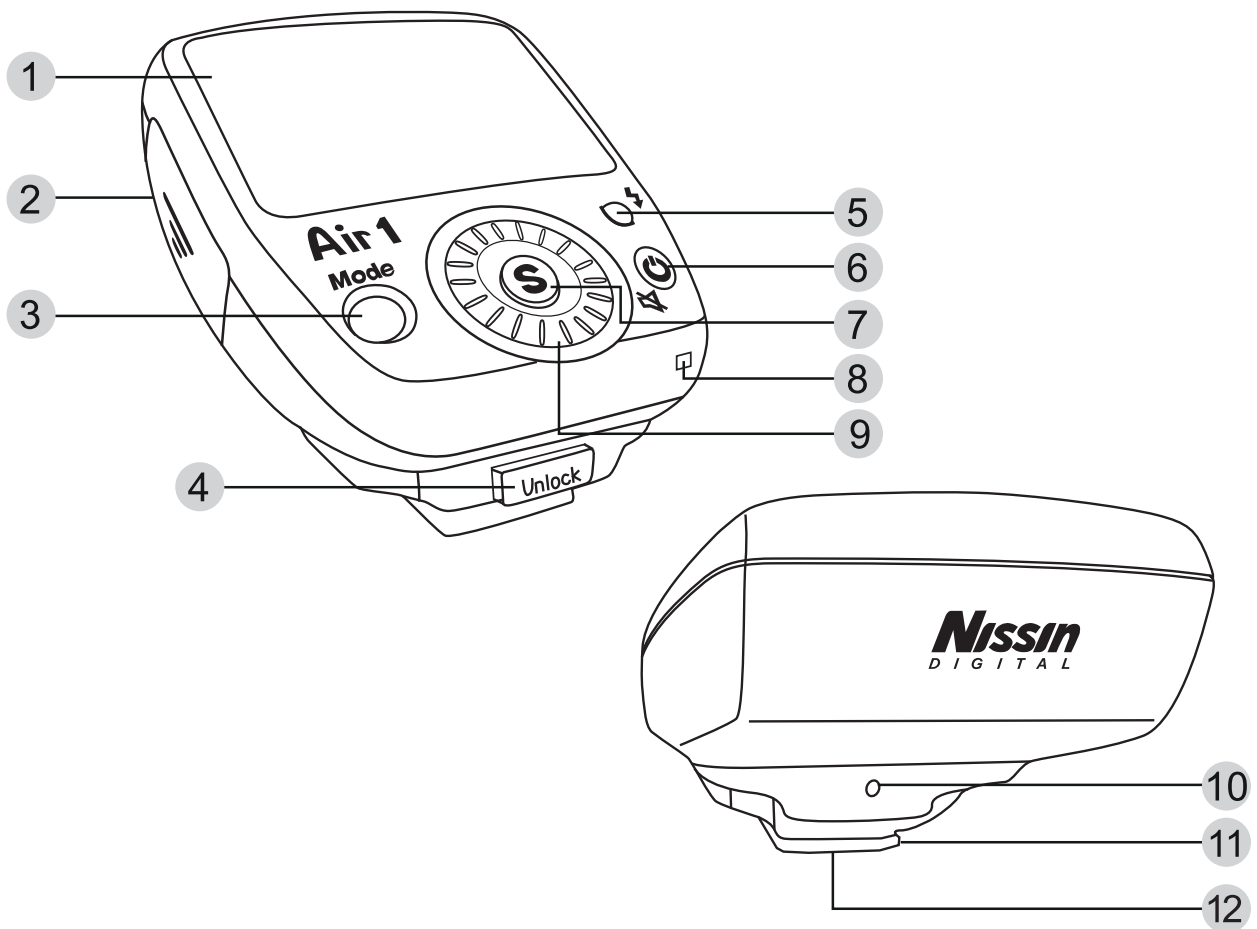

- 1 LED panel
- 2 Battery compartment door
- 3 Mode button
- 4 Unlock button
- 5 Pilot button (Test flash button)
- 6 On/ Off switch (Sound On/ Off button)
- 7 Select/ Set button
- 8 Strap hold
- 9 Select dial
- 10 AF-assis light
- 11 Mounting foot
- 12 Hotshoe contacts

Basic Operation

Before starting wireless flash shooting.

Inserting batteries

Usable batteries - Alkaline batteries, Lithium batteries or NiMH batteries.

1. Open the battery compartment door and insert 2 x size AAA batteries as shown by the picture.
2. Make sure the + and - battery contacts are correctly inserted at the battery compartment.
3. Close the battery compartment door and slide it back in place.

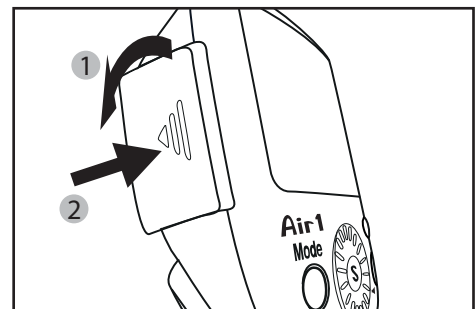
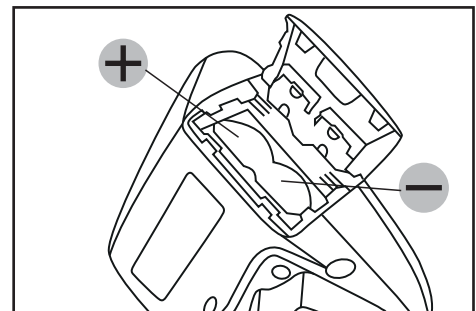
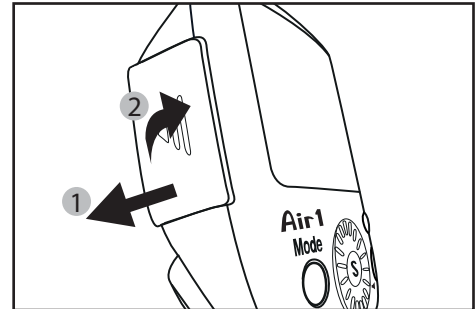

NOTE

It is recommended to use 2 batteries of the same brand and type, and replace them all at the same time.

Wrong insertion of each battery would not make electric contact.

Basic Operation

Air 1 has an energy saving power off function

To save battery energy, the Air 1 display screen dims in about 4 seconds and display screen automatically turns off in about 2 mins after the setting job is terminated. While Air 1 is in the stand-by mode, a Pilot button blinks every 2 seconds showing the commander unit is in stand-by mode. To turn on Air 1 again, press Mode/ S/ Pilot button on the Commander.

In case Air 1 is not in use for over 60 minutes, the unit is completely turned off.

To turn on Air 1 again hold On/Off switch for 1 second.

Reset setup Option

Press the Mode button for 5 seconds, all the setting will be reset to the factory default.



TTL

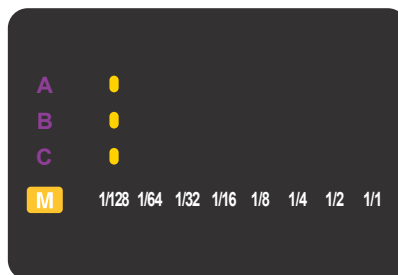

Maunal



Manual Zoom

Mounting Air 1 on the camera

1. Slide the mounting foot of Air 1 into the hotshoe of the camera.
2. Make sure that the mounting foot will lock (with a “click”) when it has been inserted completely.

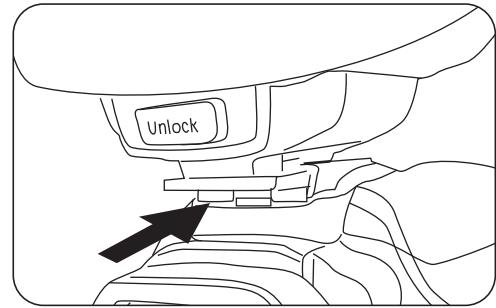

Removing Air 1 from the camera

- Press the unlock button and slide the mounting foot of Air 1 off the hotshoe of the camera.

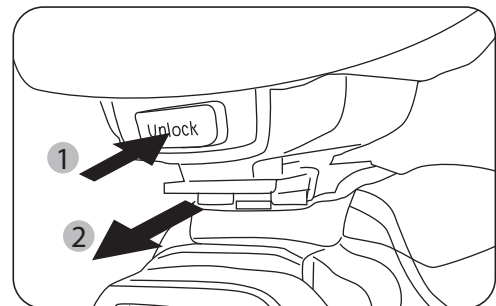



Wireless Flash Shooting

Wireless Setting

To perform wireless shooting, set the commander Air 1 (master unit) and flash (slave unit) with the following procedure.



Binding before use.

Step 1: All the units are OFF

Step 2: Binding setting

Nissin flitser Di700A

1. Press and hold 'On' and ' Pilot' button simultaneously for 3 sec
 2. "Beep" sound = On
- * Repeat when using more than 1 flash
 - * Bind up to 21 flashes

Nissin flitser i60A

1. Rotate the dial to 'Group C'
 2. Press and hold 'On' and ' Pilot' button simultaneously for 3 sec
 3. "Beep" sound = On
- * Repeat when using more than 1 flash
 - * Bind up to 21 flashes

Nissin commander Air 1

1. Hold "S" and ON/OFF button for 3 seconds
2. Pilot button Blinking for about 5 seconds

Nissin flash Di700A / i60A

"Beep" sound STOP ----- **Binding setting completed**

**2~4s signal delay on commander*

**Do not operate until the binding process is finished*

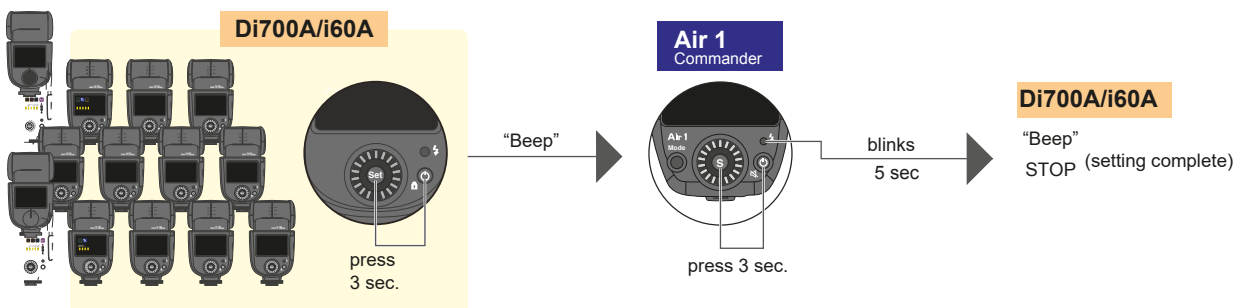

NOTE

The binding setting is memorized and remains unchanged when power on/off.

For a test-flash, press the pilot button.

The Nissin commander attached to the camera is called the master unit, and a flash that is wirelessly controlled is called slave unit.

Di700A/i60A will be switched to Radio Transmission Mode (2.4GHz transmission) once connecting to NAS Commander, all functions will be controlled through NAS Commander. Otherwise, Optical Transmission mode will be enabled by default.





Wireless Flash Shooting

Step 3: Channel setting

To avoid interference with wireless multiple flash system using radio transmission that are used by other photographers, or with other devices that use radio waves (wireless), you can change the transmission channel and wireless radio ID.

Nissin commander Air 1

1. Hold "S" button for 3 seconds
2. Display screen automatically change to
3. Rotate the dial  to select 1 in 8 Channels
4. Press  1 time to confirm
5. "Beep" sound in Nissin Flash Di700A/i60A
6. Channel setting completed

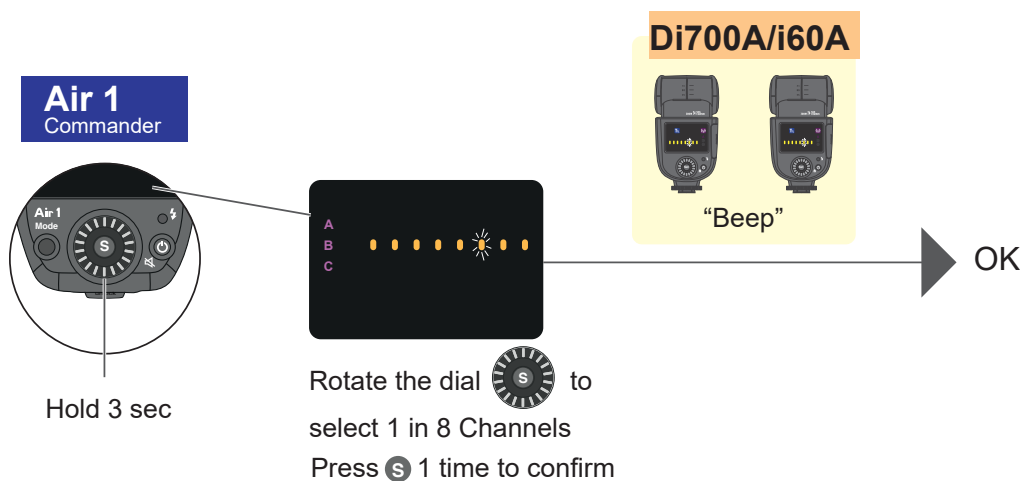
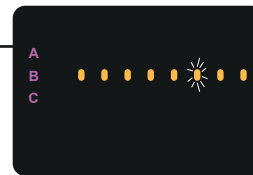

NAS Wireless Flash Shooting

Step 4: Desire group setting

Di700A

Group A/B/C setting in Di700A - (TTL)

Group A

Group B

Group C

i60A

Group B TTL-setting on i60A

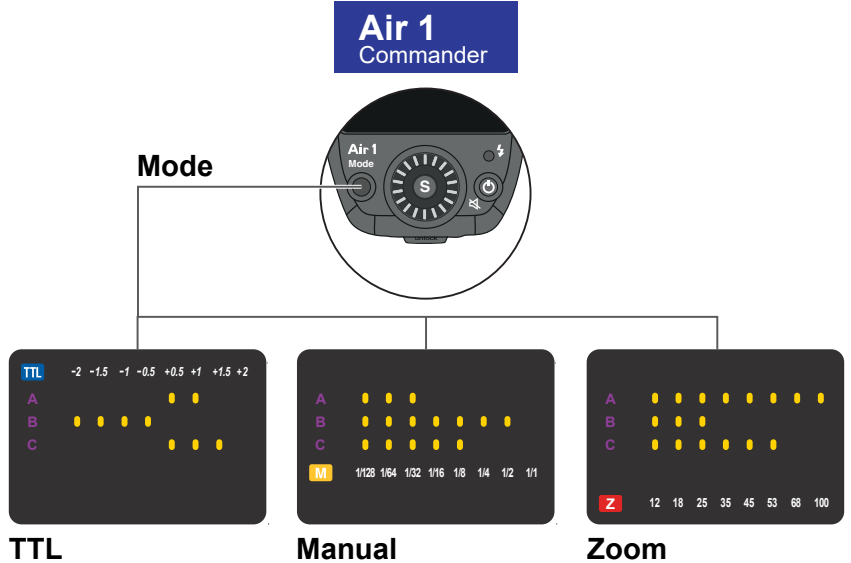

1. Press Mode to select the Flash mode **TTL** / **M** / **Z**
2. Press to select the group **A** / **B** / **C** / **ABC**
3. Rotate the dial to adjust the EV compensation (TTL)/ Power output (Manual)/ Zoom position (Zoom) in each group.
4. To turn off the group press when the group is blinking
5. Press Mode again to start using the flash.

Control the Flash “Beep” sound On/Off

Nissin commander Air 1

1. Press On/Off button
2. Color change on Pilot button
 Orange - sound On
 White - sound Off

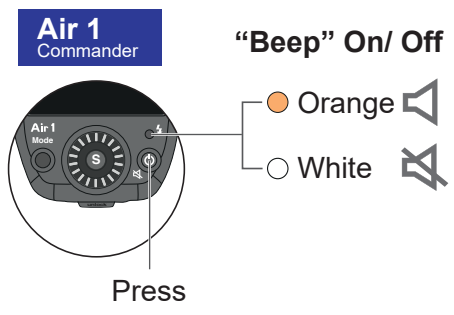

Control TTL flash power compensation

1. Group A/B/C setting in each Di700A/i60A
2. Press Mode button to select the Flash mode **TTL** in Air 1
3. Press **S** to select the group **A** / **B** / **C** / **ABC**
4. Rotate the dial  to adjust the EV compensation (TTL)

TTL flash power compensation is provided in 9 steps by half Ev increments for -2.0, -1.5, -1.0, -0.5, 0, +0.5, +1.0, +1.5 and +2.0 Ev.

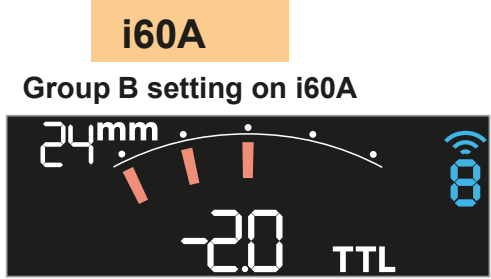
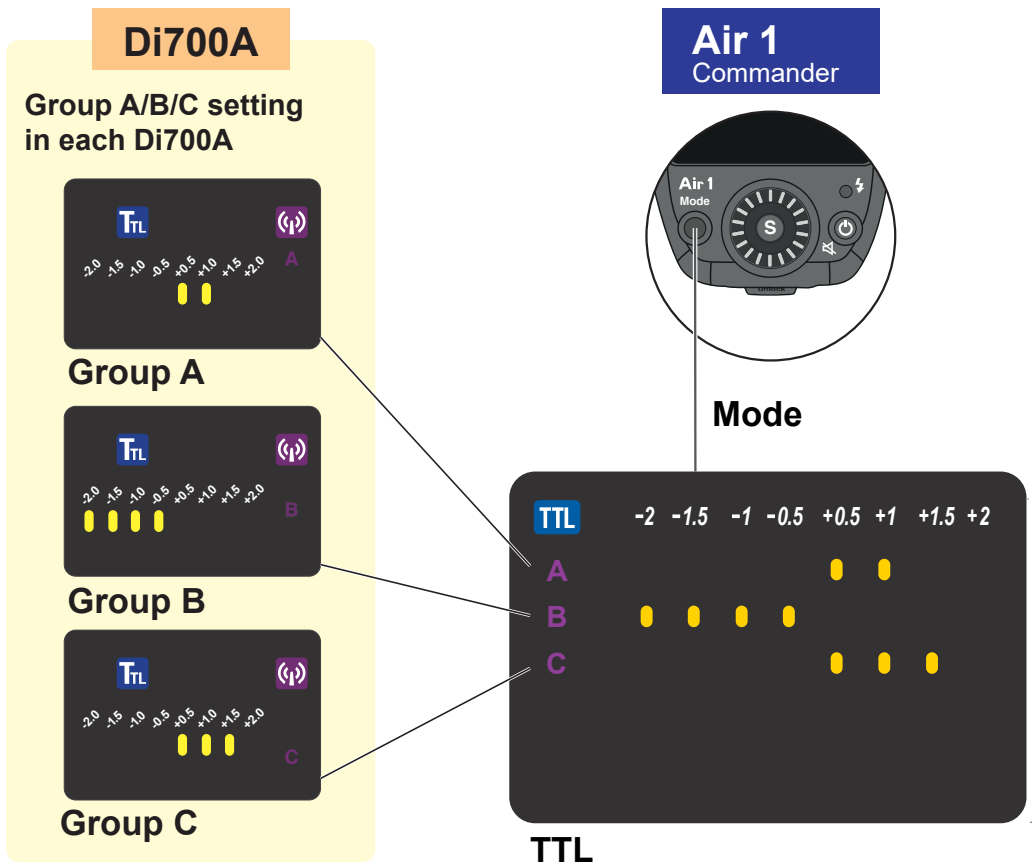

M

Manual Exposure Flash

Wireless control Manual power output

1. Group A/B/C setting in each Di700A/i60A
2. Press Mode to select the Flash mode **M** in Air 1
3. Press **S** to select the group **A** / **B** / **C** / **ABC**
4. Rotate the dial  to adjust the Power output (Manual)
from the left to right : 1/128 – 1/64 – 1/32 – 1/16 – 1/8 – 1/4 – 1/2 – 1/1 (Full) power.

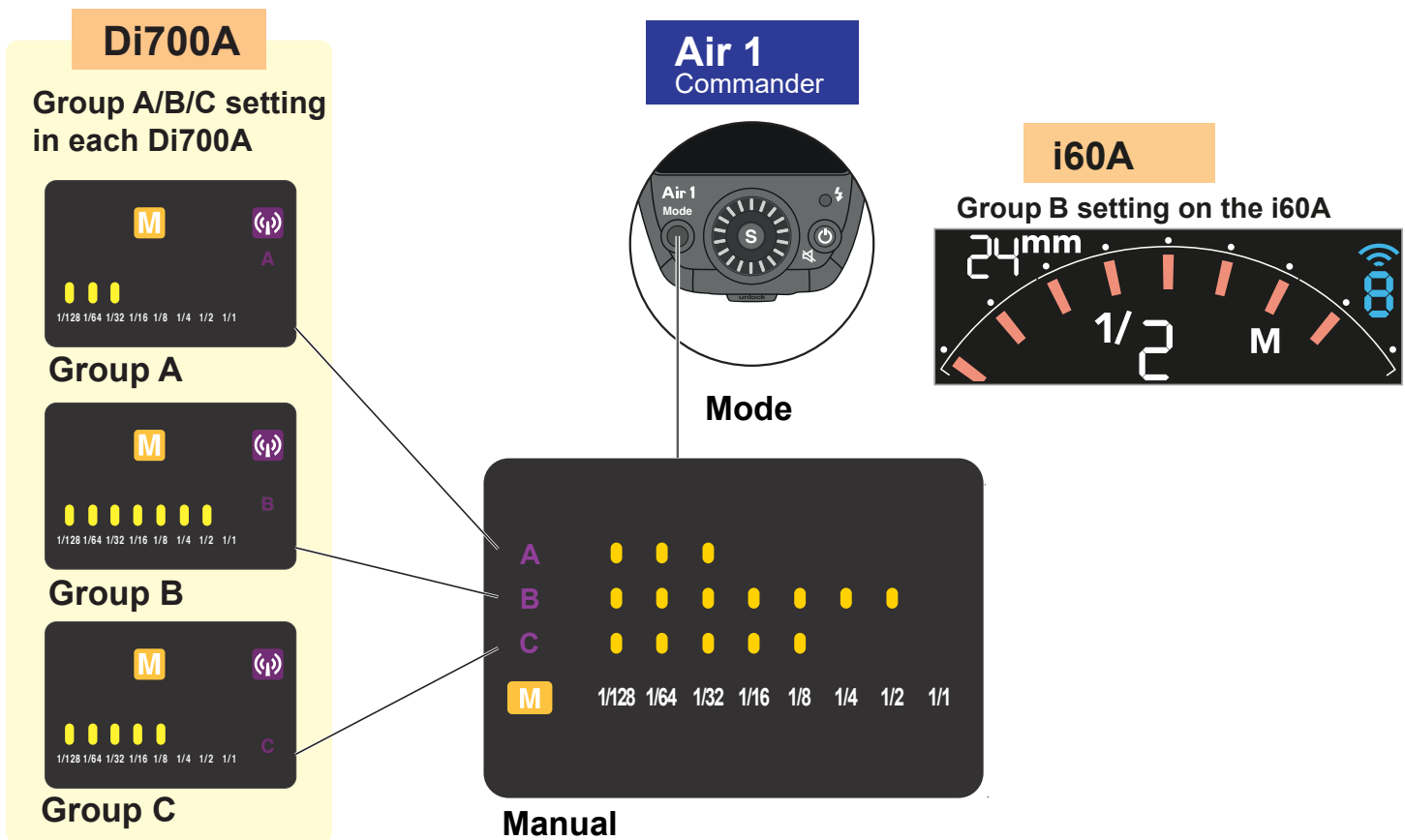

HSS High-Speed Synchronization

- High-speed Synchronization: In M/ TTL mode.
- High-speed Synchronization is controlled by Air 1.
- **To enable/ disable on Air 1:**
 - ON:** Press and hold Pilot button in 3 seconds.
Pilot button starts blinking twice.
 - OFF:** Press and hold Pilot button in 3 seconds to cancel the setting .

Z

Manual Zoom Flash

Wireless control zoom position

1. Group A/B/C setting in each Di700A/i60A
2. Press Mode to select the Flash mode **Z** in Air 1
3. Press **S** to select the group **A** / **B** / **C** / **ABC**
4. Rotate the dial  to adjust the zoom position (Manual Zoom)
12mm/ 18mm/ 25mm/ 35mm/ 45mm/ 53mm/ 68mm/ 100mm

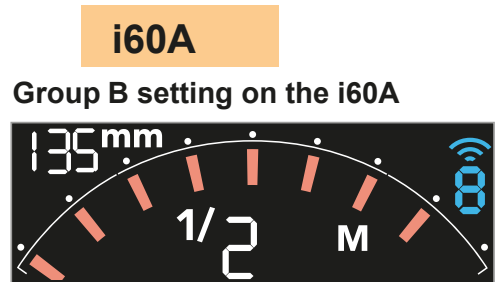
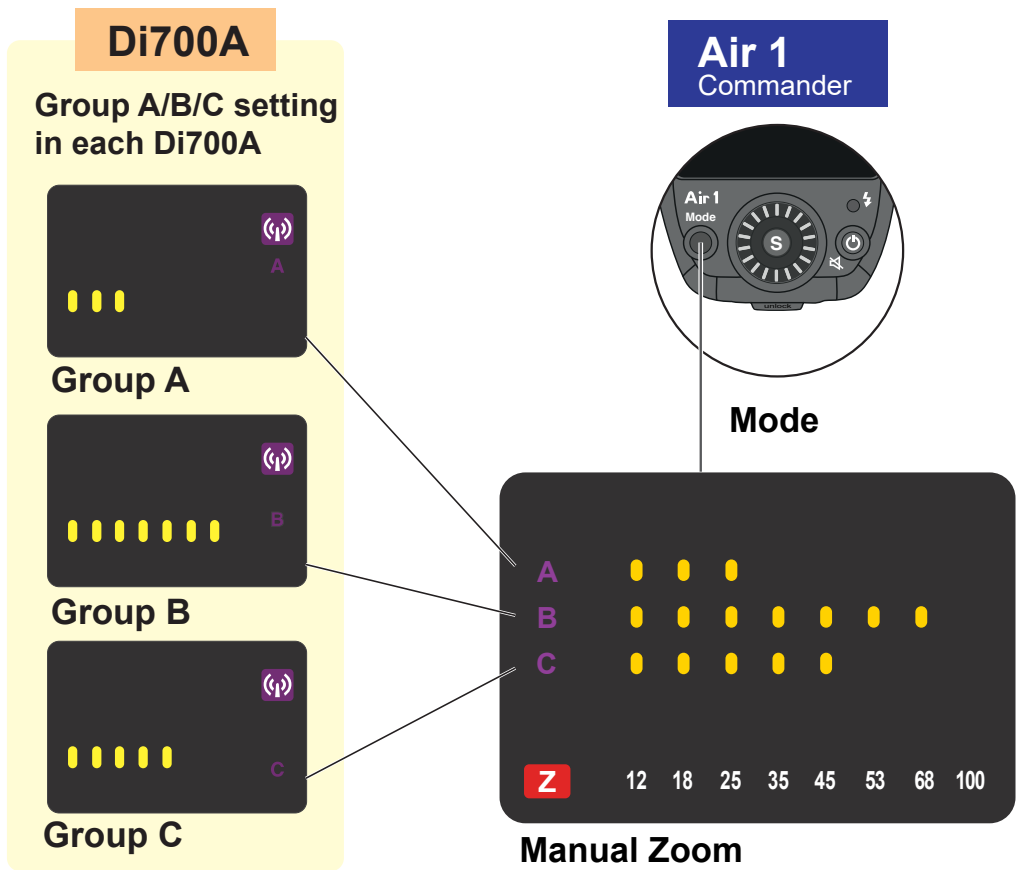



Wireless Flash Shooting

Transmission distance, approx. 30m (98.4 ft.)

When the flash is set to the Wireless mode, the power level will be controlled by the master flash. The remote works on all channels and with group A/B/C.

Set slave flash at any place and direct the flash head as you desire. The optical system may not work in bright conditions but the radio should.

Use the flash stand included. Place Di700A/i60A on to the flash stand which can be placed either on a flat surface, or on the tripod by the screw.

Autoflash shooting using One slave unit

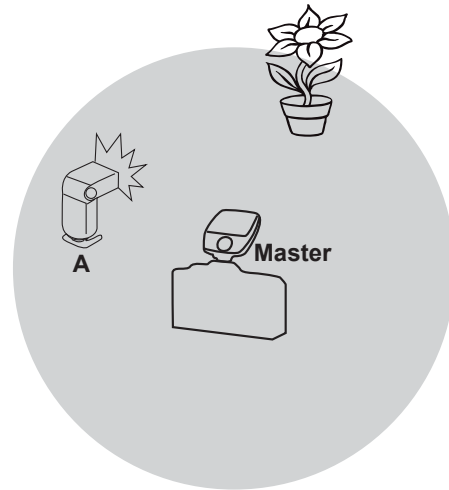

Autoflash shooting using Two slave groups

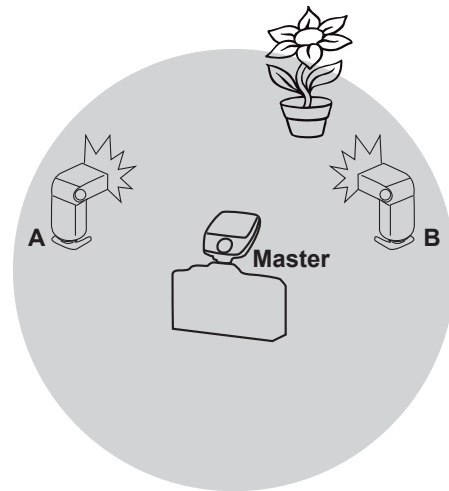

Autoflash shooting using Three slave groups

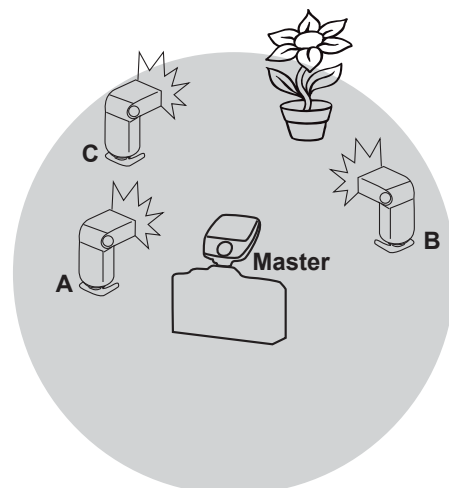

Specifications

Type	Four Third / Micro Four Third
Wireless system	Radio category
Radio specifications	2.4GHz ISM band (Obtaining technical standards conformity certification)
Channel	8 channels (channel setting in Air 1)
Flash Groups	A, B, C (3 Groups) (Group control and a specific group can stop transmitting)
Power Source	2 x AAA batteries
Function mode	TTL, Manual and Manual zoom
Continuous shooting speed	10 shots/sec
Number of flashes per charge	Approx. 3,000 flashes
Transmission distant	Max. 30m (Depending on the enviroment)
Mode	TTL, Manual and Manual zoom
Manual zoom	Manual adjustment (24/ 35/ 50/ 70/ 85/ 105/ 135/ 200 mm)
EV compensation on flash	[TTL] -2.0 ~ + 2.0 ,1/2EV step [manual] 1 ~ 1/128 (8 steps) Each group can be adjusted independently or synchronized
Synchronization modes	1st- Curtain synchronization, 2nd- Curtain synchronization, High-speed synchronization, Red-eye reduction (Olympus only), Slow synchronization
AF-assist beam effective range	0.7 ~ 5m
Operation panel	LED color panel and select dial
High-speed synchronization	1/8,000 sec
Dimensions	65(L) x 60 (W) x 50 (H)mm/ 2.6(L) x 2.4(W) x 2 (H)inch
Weight	55g / 1.9oz (without batteries)

Warranty

In case of the following reason of the defect, it may void the warranty. Please refer the respective warranty condition for details which depends on the country of purchase.

1. The product is not used in accordance with the instruction of the owner's manual.
2. The product is repaired or modified by the one who is not an authorized repair service.
3. When the product is used with the cameras not applicable, lens, adaptors or such accessories produced by the third party.
4. Fault or defect caused by fire, earthquake, flood, public pollution and such natural accident.
5. In case that the product is stored in dust, moisture, extremely high temperature or such poor condition.
6. Scratch, blemish, crush or worn out by a violent use or treatment.
7. Guarantee card without name of place purchased or date of purchase stamped, or no guarantee card.

Nissin

Nissin Japan Ltd., Tokyo
<http://www.nissin-japan.com>

Nissin Marketing Ltd., Hong Kong
<http://www.nissindigital.com>