



# LEICA Q3 43

INSTRUCTION MANUAL

## FOREWORD

Dear Customer,

We wish you a great deal of fun and success taking photographs with your new Leica Q3 43. Please read this manual thoroughly to familiarize yourself with the full scope of functions your camera has to offer. You can find all information about the Leica Q3 43 whenever you need it at <https://leica-camera.com>.

Your Leica Camera AG

## SCOPE OF DELIVERY

Before using your camera for the first time, please check that the accessories supplied are complete\*.

- Leica Q3 43 with attached lens hood
- Lithium-ion rechargeable battery Leica BP-SCL6
- Lens hood cap
- Carry strap
- Thread protection ring
- Accessory shoe cover
- USB-C cable
- Flyer (Leica account)
- Flyer: Warning information coin cell
- Quick Start Guide
- Test certificate
- CE flyer

---

\* Subject to change with regard to construction and appearance.

## REPLACEMENT PARTS / ACCESSORIES

Please contact Leica Customer Care or visit the Leica Camera AG website for information on the extensive range of Leica replacement parts/accessories:

<https://leica-camera.com/en-US/photography/accessories>

Only the accessories specified and described in this manual or by Leica Camera AG must be used with the camera (battery, charger, mains plug, mains cable, etc.). These accessories must only be used with this product. Third-party accessories may result in malfunctions or damage to the product.

Please read the chapters "Legal information", "Safety remarks", and "General information" before using your camera for the first time. Knowledge of the content will prevent inadvertent damage to the product, possible injuries and other risks.

## LEGAL INFORMATION

### COPYRIGHT NOTICE

- Compliance with copyright laws is mandatory. The recording and publication of pre-recorded media like tapes, CDs, or other published or broadcast material may breach copyright laws. The same applies for all software supplied as part of the scope of delivery.
- The following applies for all video material created with this camera: This product is governed by the AVC Patent Portfolio license and is meant for private use by a consumer only. The device may furthermore be used for purposes for which the consumer receives no remuneration, e.g. (i) encoding in accordance with the AVC Standard (“AVC Video”) and/or (ii) decoding of AVC Video that was encoded by a consumer in accordance with the AVC Standard within the scope of personal use and/or which the consumer has received from the provider, who is in possession of a license to offer AVC Video. No license is granted or implied for any other use. Any other use, specifically the provision of AVC video in exchange for remuneration, may require a separate license agreement with MPEG LA, L.L.C. Please visit the MPEG LA, L.L.C. website at: [www.mpegla.com](http://www.mpegla.com) for more information.
- The designations SD, SDHC, SDXC, microSDHC and their associated logos are registered trademarks of SD-3C, LLC.

## LEGAL INFORMATION ABOUT THIS MANUAL

### COPYRIGHT

All rights reserved.

All text, images and graphics are subject to copyright and other laws to protect intellectual property. They must not be copied, modified or used for any purpose including trade purposes.

### TECHNICAL DATA

Product changes with regards to the products or services may occur after the editorial deadline. The manufacturer reserves the right to effect structural or shape changes, color deviations and changes to the scope of delivery or service, where these changes or deviations are reasonably acceptable for the customer, while taking into consideration the interests of Leica Camera AG. To that extent, Leica Camera AG reserves the right to changes and errors. The images in this manual may depict accessory, special features or other items that are not part of the standard scope of delivery or service. Some pages may contain model types and services, which are not offered in specific countries.

### BRANDS AND LOGOS

The brand names and logos used in this document are protected trademarks. These brands or logos must not be used without prior approval by Leica Camera AG.

### LICENSE RIGHTS

Leica Camera AG intends to provide you with innovative and informative documentation. Due to the amount of creativity that has gone into its design, we ask for your understanding that Leica Camera AG must protect its intellectual property, including patents, trademarks and copyrights, and that possession of the documentation does not infer any licensing rights of the intellectual property of Leica Camera AG.

## REGULATORY INFORMATION

You will find the manufacturing date of your camera on the stickers in the Warranty Card and/or on the packaging.

The date format is year/month/day.

## COUNTRY-SPECIFIC LICENSES

Specific regional approvals for this device can be found in the camera menu.

- Select **Camera Information** in the main menu
- Select **Regulatory Information**

## LICENSE INFORMATION

The device-specific license information can be found in the camera menu.

- Select **Camera Information** in the main menu
- Select **License Information**

## CE MARK

The CE mark on our products documents compliance with the fundamental requirements of applicable EU guidelines.

### English

#### Declaration of Conformity (DoC)

"Leica Camera AG" hereby declares that this product is in compliance with the basic requirements and other relevant provisions of Directive 2014/53/EU.

Customers can download a copy of the original DoC for our Radio Equipment products from our DoC server:

<https://cert.leica-camera.com>

Please contact Leica Camera AG, Am Leitz-Park 5, 35578 Wetzlar, Germany in case of any further questions

**Usable frequency band/ Usage limitations:**

**see technical data**

## DISPOSAL OF ELECTRICAL AND ELECTRONIC EQUIPMENT

(Applies within the EU and for other European countries with active waste separation policies.)



This device contains electrical and/or electronic components which must not be disposed of in general household waste. Instead, it should be disposed of at a recycling collection point provided by your local authority. This service is free of charge. Any standard or rechargeable batteries used in this device must be removed and disposed of separately in accordance with local regulations.

Please contact your local authorities, waste disposal collection point or the retailer, from whom you purchased the device for more information on correct waste disposal.

## IMPORTANT NOTES REGARDING THE USE OF WLAN/BLUETOOTH®

- Appropriate measures must be taken to ensure security and protect against disruptions to the systems in place where devices or computer systems are in use that require more stringent security than WLAN devices.
- Leica Camera AG shall not accept liability for damages arising from the use of the camera for purposes other than as a WLAN device.
- It is assumed that the WLAN function will be used in countries where this camera is sold. There may be a risk of breaching statutory wireless communication regulations when using the camera in other countries. Leica Camera AG shall not accept liability for such breaches.
- Please note that there is a risk of data that is transmitted and received wirelessly being intercepted by third parties. We highly recommend that you activate encryption in the wireless access point settings to ensure data safety.
- Avoid using the camera in areas where it can be exposed to magnetic fields, static electricity or other interferences, e.g. near a microwave oven. RF transmissions may otherwise not reach the camera.
- Using the camera near devices like microwave ovens or mobile phones that use the 2.4 GHz RF band may negatively affect the performance of both devices.
- Do not attempt to connect to wireless networks you are not authorized to use.
- The device will automatically search for wireless networks, once the WLAN function is enabled. A list, including networks you are not authorized to access, will be displayed (SSID: Network identifier for a WLAN network). Do not attempt to connect to third party network, as this could be construed as unauthorized access.
- We recommend disabling the WLAN function while on an aircraft.
- The use of the WLAN-RF band between 5150 MHz and 5350 MHz is permitted only in enclosed spaces.
- Please read the important notes on specific functions of Leica FOTOS on p. 212.

## IMPORTANT NOTES ON CHARGING VIA USB / WIRELESS CHARGING

- Use a switching adapter with a max. 100 W output or less, which complies with the USB-PD standard. Ensure compliance with the safety standards IEC62368-1 (ES1, PS2-compliant – 60V or less, 100 W or less). Contact the manufacturer of the switching adapter if you are not sure that it complies with the safety standards.

# SAFETY REMARKS

## GENERAL INFORMATION

- Do not use your camera in the immediate vicinity of devices that generate powerful magnetic, electrostatic or electromagnetic fields (e.g. induction ovens, microwave ovens, television sets or computer screens, video game consoles, cell phones, broadcasting equipment). Their electromagnetic fields can interfere with image capturing.
- Strong magnetic fields, e.g. from speakers or large electric motors can damage the stored data or disrupt shooting.
- Switch off the camera, remove the battery briefly, replace it and switch the camera back on in case of a camera malfunction due to the effects of electro-magnetic fields.
- Do not use the camera in the immediate vicinity of radio transmitters or high-voltage power lines. Their electromagnetic fields may also interfere with image capturing.
- Always store small parts e.g. the accessory shoe cover as follows:
  - out of the reach of children
  - in a safe location, where they will not get lost or stolen
- State-of-the-art electronic components are sensitive to static discharge. You can easily pick up charges of several 10,000 volts by simply walking on synthetic floor coverings. A static discharge can occur when you touch the camera and especially if it is placed on a conductive surface. A static discharge on the camera housing poses no risk for the electronics. Despite built-in safety circuits, you should avoid direct contact with external camera contacts like those in the hot shoe.
- Use a cotton or linen cloth instead of a microfiber cloth from an optician's (synthetic) when cleaning the contacts. Make sure to discharge any electrostatic charge by deliberately touching a heating or water

pipe (conductive, grounded material). Dirt deposits and oxidation on the contacts can be avoided by storing your camera in a dry location with the lens cap and the flash shoe/viewfinder cap (in system cameras) attached.

- Only use accessories specified for this model to prevent faults, short circuits or electric shock.
- Do not attempt to remove parts of the housing (covers) yourself. Repairs must be done at authorized service centers only.
- Protect the camera against contact with insect sprays and other aggressive chemicals. Petroleum spirit, thinner and alcohol must not be used for cleaning. Some chemicals and liquids can damage the camera housing or the surface finish.
- Rubber and plastics are known to expel aggressive chemicals and should therefore not be kept in contact with the camera for extended periods of time.
- Prevent any sand or dust or water penetration into the camera, e.g. during snowfall or rain or on the beach. Be extra careful when changing the lens (in system cameras) and when inserting or removing the memory card and rechargeable battery. Sand and dust can damage the camera, the lens, the memory card and the battery. Moisture can cause malfunctions and irreparable damage to the camera and memory card.

## LENS

- A camera lens can have the effect of a magnifying glass when exposed to intense frontal sunlight. The camera must therefore be protected against extended exposure to direct sunlight.
- Attaching the lens cap and keeping the camera in the shade or ideally in its camera case, will help prevent damage to the interior of the camera.

## RECHARGEABLE BATTERY

- Improper use of the batteries or the use of unapproved battery types may result in an explosion!

- Do not expose the rechargeable battery to sunlight, heat, humidity or moisture for prolonged periods of time. Likewise, the batteries must not be placed in a microwave oven or a high-pressure container as this would pose a fire or explosion hazard!
- Do not under any circumstances charge or insert a damp or wet battery into the camera!
- A safety valve in the battery ensures that any excess pressure caused by improper handling is discharged safely. It is nevertheless important to dispose of a bloated battery immediately. It may pose an explosion hazard!
- Keep the battery contacts clean and easily accessible. Although lithium-ion rechargeable batteries are secured against short circuits, they should still be protected against contact with metal objects like paper clips or jewelry. A short-circuited battery can get very hot and cause severe burns.
- When a battery is accidentally dropped, make sure to check the housing and the contacts immediately for any damage. A damaged battery can damage the camera.
- The battery must be removed from the camera or charger and must be replaced immediately in case of a strange smell, discoloration, deformation, overheating or leakage. Continued use of the battery may result in overheating, which can cause fire and/or explosion!
- Never throw batteries into a fire as they may explode.
- Keep the battery away from sources of heat in case of leakage or if you smell burning. Leaked fluid can catch fire!
- The use of other chargers not approved by Leica Camera AG can cause damage to the batteries – and in extreme cases – cause serious or life-threatening injuries.
- Make sure that the power socket is freely accessible at all times.
- Do not attempt to open the battery or the charger. Repairs must only be carried out by authorized workshops.
- Keep batteries out of the reach of children. Batteries can cause suffocation when swallowed.

## FIRST AID

- Battery fluid may cause blindness if it comes into contact with the eyes. Rinse the eyes thoroughly with clean water immediately. Avoid rubbing. Seek medical attention immediately.
- Leaked battery fluid poses an injury hazard when it comes in contact with clothing or skin. Rinse the affected areas thoroughly with clean water.

## CHARGER

- Using the charger in the vicinity of broadcasting receivers may interfere with reception. Ensure a distance of at least 1 m between the charger and the receiver.
- When the charger is in use, it may emit a buzzing sound – that is normal and not a malfunction.
- Disconnect the charger from the mains when it is not in use, as it consumes electricity (a very small amount), even if no battery is inserted.
- Always keep the charger contacts clean, and never short-circuit them.
- Only the mains cables supplied must be used. The mains cables must only be used for the supplied charger unit. Do not attempt to use the mains cable or charger unit for other purposes.

## MEMORY CARD

- Never remove the memory card during a data save or card reading process. The camera must not be switched off or be subjected to impact or vibrations while working.

- Do not open the cover/remove the memory card or the battery from the camera while the status LED is lit, which indicates memory access. Data on the card may otherwise be destroyed and camera malfunctions may occur.
- Do not drop or bend memory cards as this will cause damage and result in the loss of stored data.
- Do not touch the connections on the reverse of the memory card and keep them clean and dry.
- Keep memory cards out of the reach of children. Swallowing a memory card may cause suffocation.

## FLASH

- The use of incompatible flash units with your Leica Q3 43 may result in irreparable damage to the camera and/or the flash unit.

## SENSOR

- Cosmic radiation (e.g. during flights) may cause pixel defects.

## CARRY STRAP

- Carry straps are usually made of very robust material. You should therefore keep it out of the reach of children. A carry strap is not a toy and poses a strangulation risk.
- Use the carry strap only for its intended purpose on a camera or on binoculars. Any other use poses the risk of injury and may possibly result in damage to the carry strap and is therefore not permitted.
- Carry straps should also not be used for cameras/binoculars during sports activities that pose a risk of entanglement (e.g. when mountain climbing and similar outdoor activities).

## TRIPOD

- When using a tripod, make sure it is standing securely and turn the camera only by turning the tripod, not the actual camera. Ensure that the tripod screw is hand-tightened only. Avoid transporting the camera while the tripod is attached. You might injure yourself or others, and the camera could suffer damage.

## GENERAL INFORMATION

Please read the section about “Care/Storage” for more information about what to do in case of problems.

### CAMERA/LENS

- Make a note of the serial numbers of your camera and lenses, as this information will be extremely important in case of loss.
- Depending on model, you will find the serial number of your camera on the flash shoe or engraved in the underside of the camera.

### LCD PANEL

- Condensation may form on the LCD panel if the camera is exposed to great temperature fluctuations. Wipe the screen carefully with a soft, dry cloth.
- The screen image will initially be slightly darker than normal if the camera is very cold when it is switched on. The normal level of brightness will be reached as soon as the LCD panel warms up.

### RECHARGEABLE BATTERY

- The rechargeable battery must only be charged within a specific temperature range. See chapter “Technical Data” (p. 234) for details about operating conditions.
- Lithium-ion batteries can be charged at any time, regardless of their current charge level. A partially charged battery will charge to full capacity faster than a fully discharged one.
- The rechargeable batteries come only partly charged ex works and are electronically secured. Initially, the rechargeable battery will not be ready for operation due to its safety lock feature. Before initial use, the rechargeable battery must be fully charged for the electronic lock to disengage.
- A new battery only reaches its full capacity after it has been fully charged and – by using it in the camera – depleted 2 to 3 times. This depletion process should be repeated roughly every 25 cycles.
- Battery and charger heat up during the charging process. That is normal and not a malfunction.
- Rapid flashing of the two LEDs (> 2 Hz) when charging commences indicates a charging error (e.g. maximum charging time exceeded, voltages or temperatures outside permitted ranges or a short circuit). Disconnect the charger from the mains and remove the battery. Ensure that the above temperature conditions are met and then restart the charging process. Please contact your dealer, the Leica representative in your region or Leica Camera AG if the problem persists.
- Rechargeable lithium-ion batteries generate power by way of internal chemical reactions. These reactions are influenced by ambient temperature and humidity. Do not expose the battery to extreme temperatures (high or low) for extended periods of time (e.g. in a parked car in the summer or winter) to ensure a maximum service life.
- However, every battery has its limits – even in optimal conditions! After several hundred charging cycles, the operating times will get significantly shorter.
- The replaceable battery supplies power to a backup battery, which is permanently installed in the camera. This backup battery retains the date and time for some weeks. Once the backup battery is depleted, it must be replenished by inserting a charged main battery. The time and date will have to be set again after a full depletion of both batteries.
- As the battery capacity deteriorates or if using an older battery, warning messages may appear and some functions may be restricted or blocked entirely.
- Always remove the battery if the camera will not be used for an extended period of time. Make sure to switch the camera off via the main switch before removing the battery. Leaving the battery in the camera will result in a deep discharge after a few weeks.

Voltage levels will decrease significantly, as the camera uses a low idle current to maintain settings.

- Dispose of damaged batteries in accordance with the relevant regulations at an approved collection point for proper recycling.
- The date of manufacture can be found on the battery. The date format is week/year.

## MEMORY CARD

- The range of available SD/SDHC/SDXC cards on the market is too extensive for Leica Camera AG to test for compatibility and quality. Generally, any type of memory card may be used without any damage to the camera or memory card. As some “no name” cards may not fully comply with the SD/SDHC/SDXC standards, Leica Camera AG cannot provide any guarantee of function.
- We recommend formatting memory cards from time to time, as fragmented residual data from deleted files may block some of the storage capacity.
- Generally, it is not necessary to format (initialize) memory cards that have been previously used. Formatting will, however, be necessary if you insert an unformatted memory card or a card that was formatted in another device (e.g. a computer) for the first time.
- We recommend backing up your data on a PC, because electromagnetic fields, static electricity and any damage to the memory card or camera defects may result in irretrievable damage or loss of your data.
- SD, SDHC, and SDXC memory cards come with a write protection slider to prevent accidental overwriting. This slider is located on the non-beveled side of the card. All data on the card is protected when the slider is set to its lower position, marked LOCK.
- All data stored on the memory card will be lost during formatting. Formatting will not be prevented by a deletion protection set for individual shots.

## SENSOR

- Depending on particle size, any dust or dirt particles adhering to the sensor glass may result in noticeable dark spots or blemishes in recordings (in system cameras). Alternatively, send your camera to the Leica Customer Care department for sensor cleaning (see p. 244). This service is not part of the warranty offering and will therefore incur charges.

## DATA

- All data, including personal information, may be changed or deleted due to incorrect or accidental operation, static discharge, accidents, malfunctions, repairs and other actions.
- Please note that Leica Camera AG does NOT accept liability for direct or consequential damage due to the manipulation or destruction of data and personal information.

## FIRMWARE UPDATE

Leica is continuously working on the further improvement and optimization of Leica Q3 43. As digital cameras have many functions that are controlled electronically, improvements and enhancements to the functions can be installed on the camera retroactively. Leica releases so-called firmware updates at irregular intervals. Cameras are always supplied ex works with the latest firmware installed or you can download the latest version from our website yourself and transfer it to your camera.

You will receive a newsletter informing you of the availability of a new firmware update if you register your camera on the Leica Camera homepage.

Visit the download section or the “Customer Area” for information about how to register or how to get firmware updates for your Leica Q3 43. Additionally, you can find information about changes or additions to the manual at: <https://club.leica-camera.com>

# WARRANTY TERMS LEICA CAMERA AG

Dear Leica Customer,  
congratulations on the purchase of your new Leica product – you are now the proud owner of a world-class brand product.

In addition to your statutory warranty claims against your seller, we, Leica Camera AG ("LEICA"), grant you voluntary warranty services for your Leica product in accordance with the following stipulations ("Leica Warranty"). The Leica warranty therefore does not limit your statutory rights as a consumer under applicable law or your rights as a consumer against the dealer with whom you have concluded the purchase contract.

## LEICA WARRANTY

You have purchased a Leica product that has been manufactured according to special quality guidelines and tested by experienced specialists during the various stages of production. We provide the following Leica Warranty, valid as of April 1, 2023, for this Leica product and including the accessory parts in the original packaging. Please note that we do not offer any warranty for commercial use.

We offer an extended warranty for some Leica products, provided you register for a Leica account. Please visit [www.leica-camera.com](http://www.leica-camera.com) for more details.

## LEICA WARRANTY SCOPE

During the warranty period, complaints based on manufacturing and material defects will be remedied free of charge, at LEICA's discretion, by way of repair, replacement of defective parts, or exchange for a similar Leica product in perfect condition. Replaced parts or products become the property of LEICA.

Further claims of any kind and on any legal grounds whatsoever in connection with this Leica Warranty are excluded.

## EXCLUDED FROM THE LEICA WARRANTY

Parts subject to wear and tear (e.g. eyecups, leather coverings, carry straps, armoring, batteries), and parts under mechanical stress are excluded from the Leica Warranty, unless the defect was caused by manufacturing or material defects. That also applies to any exterior damage.

## VOIDED CLAIMS UNDER LEICA WARRANTY

Claims under the warranty are void if the defect in question is due to improper handling; they may also be void if e.g. third-party accessories have been used, the Leica product has not been opened professionally or has not been repaired professionally. Claims for warranty services shall similarly be void if the serial number is unrecognizable.

## CLAIMS UNDER THE LEICA WARRANTY

We require a copy of the proof of purchase of your Leica product from a LEICA-authorized dealer ("Authorized Leica Dealer") before we can accept any claim under the warranty. The purchase receipt must show the date of purchase, the Leica product with its article number and serial number, and details of the Authorized Leica Dealer. We reserve the right to request the original receipt. Alternatively, you may send us a copy of the warranty card; please note that the Warranty Card must be filled out correctly, and the product must have been purchased from an Authorized Leica Dealer.

Please send your Leica product with a copy of your purchase receipt or the Warranty Card alongside a description of the issue.

**Leica Camera AG, Customer Care**  
**Am Leitz-Park 5, 35578 Wetzlar, Germany**

**Email: [customer.care@leica-camera.com](mailto:customer.care@leica-camera.com)**

**Phone: +49(0)6441 2080-189**

or to an Authorized Leica Dealer.

Leica Product Image	Warranty Term
all products	2 years

### **Leica Q3 43 comes with splash water and dust protection.**

The camera was tested under controlled laboratory conditions and is classes as IP52 in accordance with DIN EN 60529. Please note: The splash water and dust protection coating is not permanent and will diminish over time. Please read the section on "Care/Storage" for detailed instructions on how to clean and dry the camera. The warranty does not cover liquid damage. Any attempt to open the camera casing by an unauthorized retailer or service partner will cause an immediate expiration of the splash water and dust warranty.

# TABLE OF CONTENTS

FOREWORD .....	2
SCOPE OF DELIVERY .....	2
REPLACEMENT PARTS / ACCESSORIES .....	3
LEGAL INFORMATION .....	4
SAFETY REMARKS .....	7
GENERAL INFORMATION .....	10
WARRANTY TERMS LEICA CAMERA AG .....	12
TABLE OF CONTENTS .....	14
PART DESIGNATIONS .....	20
DISPLAYS .....	22
PHOTO .....	22
VIDEO .....	24
PREPARATION .....	26
ATTACHING THE CARRY STRAP .....	26
PREPARING THE CHARGER BC-SCL4 .....	26
PREPARING THE CHARGER (LEICA USB-C DUAL CHARGER BC-SCL6) .....	26
CHARGING THE BATTERY .....	27
CHARGING VIA USB .....	28
INSERTING/REMOVING THE BATTERY .....	28
INSERTING/REMOVING THE MEMORY CARD .....	29
ATTACHING/DETACHING THE LENS HOOD .....	31
DIOPTER SETTINGS .....	32
WIRELESS CHARGING HANDGRIP HG-DC1 .....	32
WIRELESS CHARGING OF THE CAMERA .....	33
CAMERA OPERATION .....	34
CONTROL ELEMENTS .....	34
MAIN SWITCH .....	34
SHUTTER BUTTON .....	35
SHUTTER-SPEED DIAL .....	36
THUMBWHEEL .....	36
THUMBWHEEL BUTTON .....	37

DIRECTIONAL PAD/CENTER BUTTON .....	37
PLAY BUTTON/MENU BUTTON .....	38
LCD PANEL .....	38
FUNCTION BUTTONS .....	40
LCD PANEL (TOUCH SCREEN) .....	41
MENU CONTROL .....	42
CONTROL ELEMENTS .....	42
MENU SECTIONS .....	42
SETTINGS IN PHOTO AND VIDEO MODE .....	43
SWITCHING MENU SECTIONS .....	44
CONTROL CENTER .....	45
CUSTOMIZING THE CONTROL CENTER .....	45
MAIN MENU .....	47
MENU NAVIGATION .....	48
SUBMENU .....	50
KEYBOARD/NUMBER PAD .....	50
MENU BAR .....	51
SCALE MENU .....	51
DATE/TIME MENU .....	52
COMBI MENU (LEICA LOOKS) .....	52
USER-DEFINED OPERATION .....	54
DIRECT ACCESS TO MENU FUNCTIONS .....	54
CHANGING AN ASSIGNMENT .....	54
ACCESSING THE ASSIGNED MENU FUNCTION .....	54
LOCKING THE DIAL .....	55
USER PROFILES .....	55
CAMERA BASIC SETTINGS .....	58
MENU LANGUAGE .....	58
DATE/TIME .....	58
POWER SAVE MODE (AUTO POWER OFF) .....	59
LCD PANEL/VIEWFINDER SETTINGS .....	60
LCD PANEL/EVF USE .....	60
EYE SENSOR SENSITIVITY .....	61
BRIGHTNESS .....	61
LCD PANEL .....	61
EVF .....	61
COLOR RENDERING .....	62
LCD PANEL .....	62
EVF .....	62
AUTOMATIC LCD PANEL AND EVF SHUTDOWN .....	62

EVF FRAME RATE .....	62	CHANGING THE INFO PROFILES .....	77
ACOUSTIC SIGNALS .....	63	DEACTIVATING INDIVIDUAL INFO PROFILES .....	77
VOLUME .....	63	CUSTOMIZING THE INFO PROFILES .....	77
NOTIFICATION SIGNALS .....	63	<b>SHOW AVAILABLE .....</b>	<b>78</b>
ELECTRONIC SHUTTER SOUND .....	63	INFO BARS .....	78
AUTOFOCUS CONFIRMATION .....	63	QUICK START BAR .....	78
SILENT PHOTOGRAPHY .....	63	GRID LINES .....	78
<b>STILL IMAGE SETTINGS .....</b>	<b>64</b>	FOCUS PEAKING .....	79
FILE FORMAT .....	64	LEVEL GAUGE .....	80
JPG .....	64	CLIPPING .....	81
DNG .....	64	HISTOGRAM .....	81
SETTING THE FILE FORMAT .....	64	<b>TEMPORARY ACTIVATION/DEACTIVATION OF INDIVIDUAL FUNCTIONS .....</b>	<b>82</b>
ASPECT RATIO .....	65	<b>MF ASSIST FUNCTIONS .....</b>	<b>82</b>
LEICA LOOKS .....	65	AF ASSIST LAMP .....	82
CUSTOMIZING LEICA LOOKS .....	65	ACOUSTIC AF CONFIRMATION .....	83
LOOKS CONFIGURATION FRAME .....	65	<b>PHOTOGRAPHY .....</b>	<b>84</b>
DOWNLOADING LEICA LOOKS .....	66	DRIVE MODE .....	84
RESETTING LEICA LOOKS .....	66	FOCUSING .....	85
<b>AUTOMATIC OPTIMIZATION .....</b>	<b>67</b>	AF PHOTOGRAPHY .....	85
NOISE REDUCTION .....	67	MF PHOTOGRAPHY .....	85
NOISE REDUCTION FUNCTION FOR LONG-TERM EXPOSURE .....	67	<b>AUTOFOCUS MODES .....</b>	<b>85</b>
NOISE REDUCTION IN JPG IMAGES .....	68	INTELLIGENT AF (iAF) .....	85
<b>OPTICAL IMAGE STABILIZATION .....</b>	<b>68</b>	AFs (single) .....	85
<b>DARK AREA OPTIMIZATION (IDR) .....</b>	<b>69</b>	AFc (continuous) .....	85
DYNAMIC RANGE .....	69	<b>AUTOFOCUS METERING METHODS .....</b>	<b>86</b>
iDR FUNCTION .....	69	FIELD/SPOT METERING .....	86
<b>DATA MANAGEMENT .....</b>	<b>70</b>	ZONE/MULTI-FIELD METERING .....	86
FORMATTING A MEMORY CARD .....	70	TRACKING .....	87
DATA STRUCTURE .....	70	<b>AF DETECTION (AUTOMATIC SUBJECT RECOGNITION) .</b>	<b>87</b>
EDIT FILE NAMES .....	71	EYE/FACE/BODY DETECTION .....	88
ADDING COPYRIGHT INFORMATION .....	71	FACE DETECTION .....	88
LOGGING THE SHOOTING LOCATION .....	72	ANIMAL DETECTION .....	88
DATA TRANSFER .....	73	AF DETECTION IN COMBINATION WITH ZONE/MULTI-FIELD METERING .....	89
<b>PRACTICAL DEFAULT SETTINGS .....</b>	<b>74</b>	<b>AF QUICK SETTING .....</b>	<b>89</b>
TOUCH AF .....	74	ACCESSING AF QUICK SETTING .....	89
TOUCH AF + SHUTTER BUTTON .....	75	ADJUSTING THE AF FRAME SIZE .....	89
TOUCH AF IN EVF MODE .....	75	<b>MF ASSIST FUNCTIONS .....</b>	<b>90</b>
<b>AUXILIARY DISPLAYS .....</b>	<b>76</b>	ENLARGEMENT IN AF MODE .....	90
INFO PROFILES .....	76	AF ASSIST LAMP .....	90

ACOUSTIC AF CONFIRMATION.....	90	EXPOSURE BRACKETING.....	114
SHIFTING THE AF FRAME.....	91	SELF-TIMER.....	115
MANUAL FOCUSING (MF).....	91	SPECIAL SHOOTING MODES.....	116
MF ASSIST FUNCTIONS.....	92	DIGITAL ZOOM.....	116
FOCUS PEAKING.....	92	SCENE MODE.....	118
ENLARGEMENT IN MF MODE.....	92	PERSPECTIVE CONTROL.....	119
MACRO FUNCTION.....	94	DETECTED PERSPECTIVE IN LIVE VIEW MODE.....	120
ISO SENSITIVITY.....	94	CORRECTED PERSPECTIVE IN REVIEW MODE.....	120
FIXED ISO VALUES.....	94	JPG FORMAT IMAGES.....	120
AUTOMATIC SETTING.....	95	DNG FORMAT IMAGES.....	120
LIMITING SETTING RANGES.....	95	PERSPECTIVE CONTROL IN ADOBE LIGHTROOM® AND	
DYNAMIC ISO SETTING.....	96	ADOBE PHOTOSHOP®.....	121
WHITE BALANCE.....	96	FLASH PHOTOGRAPHY.....	121
AUTOMATIC CONTROL/FIXED SETTINGS.....	97	COMPATIBLE FLASH UNITS.....	121
MANUAL SETTING VIA METERING.....	97	FLASH EXPOSURE METERING (TTL METERING).....	122
DIRECT SETTING OF THE COLOR TEMPERATURE.....	98	SETTINGS ON THE FLASH UNIT.....	123
EXPOSURE.....	98	FLASH MODES.....	123
SHUTTER TYPE.....	98	AUTOMATIC FLASH ACTIVATION.....	123
EXPOSURE METERING METHODS.....	99	MANUAL FLASH ACTIVATION.....	123
EXPOSURE MODES.....	100	AUTOMATIC FLASH ACTIVATION AT SLOWER SHUTTER SPEEDS	
SELECTING A MODE.....	101	(LONG-TERM SYNCHRONIZATION).....	124
FULLY AUTOMATIC EXPOSURE SETTING – P.....	101	FLASH CONTROL.....	124
PROGRAM AE MODE – P.....	101	SYNC POINT.....	124
CHANGING THE PRESET SHUTTER SPEED AND APERTURE		FLASH RANGE.....	125
COMBINATIONS (SHIFT).....	102	FLASH EXPOSURE COMPENSATION.....	126
SEMI-AUTOMATIC EXPOSURE SETTING – A/S.....	102	REVIEW MODE.....	128
APERTURE-PRIORITY MODE – A.....	102	CONTROL ELEMENTS IN REVIEW MODE.....	128
SHUTTER-PRIORITY MODE – S.....	103	DIRECT ACCESS IN PLAYBACK MODE.....	129
MANUAL EXPOSURE SETTING – M.....	103	CONTROL ELEMENTS ON THE LCD PANEL.....	129
SETTING SHUTTER SPEEDS.....	104	HIDING CONTROL ELEMENTS.....	129
LONG-TERM EXPOSURE.....	105	STARTING/EXITING REVIEW MODE.....	130
FIXED SHUTTER SPEEDS.....	105	SELECTING/SCROLLING THROUGH IMAGES.....	131
T FUNCTION.....	105	INFO DISPLAYS IN REVIEW MODE.....	132
NOISE REDUCTION.....	106	PICTURE SERIES REVIEW.....	133
EXPOSURE CONTROL.....	107	PAUSE PLAYBACK.....	133
EXPOSURE PREVIEW.....	107	RESUMING PLAYBACK.....	133
EXPOSURE LOCK.....	108	SAVE AS A VIDEO.....	134
EXPOSURE COMPENSATION.....	110	CROPPED SECTION ZOOM.....	135
SHOOTING MODES.....	111	DISPLAYING MULTIPLE IMAGES AT ONCE.....	136
CONTINUOUS SHOOTING.....	111		
INTERVAL SHOOTING.....	112		

TAGGING/RATING OF IMAGES .....	138	CREATING A NEW FOLDER .....	157
DELETING IMAGES .....	138	LOGGING THE SHOOTING LOCATION .....	158
DELETING INDIVIDUAL IMAGES .....	139	DATA TRANSFER .....	159
DELETING MULTIPLE IMAGES .....	139	<b>PRACTICAL DEFAULT SETTINGS .....</b>	<b>160</b>
DELETING ALL UNRATED IMAGES .....	140	TOUCH AF .....	160
DELETING PICTURE SERIES .....	141	TOUCH AF + SHUTTER BUTTON .....	161
PREVIEW OF LATEST IMAGE .....	141	TOUCH AF IN EVF MODE .....	161
<b>VIDEO SETTINGS .....</b>	<b>142</b>	AUDIO OUTPUT .....	161
FILE FORMAT .....	142	HDMI OUTPUT WITH/WITHOUT SOUND .....	161
VIDEO FORMAT .....	142	AUXILIARY DISPLAYS .....	162
MOV .....	142	INFO PROFILES .....	162
MP4 .....	143	CHANGING THE INFO PROFILES .....	163
AVAILABLE RESOLUTIONS .....	143	DEACTIVATING INDIVIDUAL INFO PROFILES .....	163
AVAILABLE FRAME RATES .....	143	CUSTOMIZING THE INFO PROFILES .....	163
SETTING THE VIDEO FORMAT .....	144	SHOW AVAILABLE .....	164
LEICA LOOKS .....	145	INFO BARS .....	164
CUSTOMIZING LEICA LOOKS .....	145	QUICK START BAR .....	164
LOOKS CONFIGURATION FRAME .....	145	GRID LINES .....	164
DOWNLOADING LEICA LOOKS .....	146	ZEBRA .....	164
RESETTING LEICA LOOKS .....	146	FOCUS PEAKING .....	165
AUDIO SETTINGS .....	147	LEVEL GAUGE .....	166
MICROPHONE .....	147	HISTOGRAM .....	167
USB AUDIO .....	148	FRAMELINES .....	167
WIND NOISE REDUCTION .....	148	TEMPORARY ACTIVATION/DEACTIVATION OF INDIVIDUAL FUNCTIONS .....	168
VIDEO GAMMA .....	149	MF ASSIST FUNCTIONS .....	168
HLG SETTINGS .....	149	ACOUSTIC AF CONFIRMATION .....	168
L-LOG SETTINGS .....	150	<b>RECORDING VIDEO .....</b>	<b>169</b>
SETUP/MANAGEMENT OF LUT PROFILES .....	150	START/EXIT VIDEO MODE .....	169
USING LUT PROFILES .....	152	START/END VIDEO RECORDING .....	170
AUTOMATIC OPTIMIZATION .....	153	DISPLAY AND OPERATION VIA USB-PTP USING EXTERNAL ACCESSORY (LIKE GIMBALS) .....	170
VIDEO STABILIZATION .....	153	FOCUSING .....	171
DARK AREA OPTIMIZATION (IDR) .....	153	AUTOFOCUS MODES .....	171
DYNAMIC RANGE .....	153	INTELLIGENT AF .....	171
iDR FUNCTION .....	154	CONTROLLING THE AUTOFOCUS .....	172
DATA MANAGEMENT .....	155	TOUCH AF .....	172
FORMATTING A MEMORY CARD .....	155	CONTINUOUS FOCUSING .....	172
DATA STRUCTURE .....	156	AUTOFOCUS METERING METHODS .....	172
EDIT FILE NAMES .....	157	FIELD/SPOT METERING .....	173

ZONE/MULTI-FIELD METERING .....	173
TRACKING .....	173
<b>AF DETECTION (AUTOMATIC SUBJECT RECOGNITION)...</b>	<b>174</b>
EYE/FACE/BODY DETECTION .....	174
FACE DETECTION .....	175
ANIMAL DETECTION .....	175
AF DETECTION IN COMBINATION WITH ZONE/MULTI-FIELD METERING .....	175
<b>AF QUICK SETTING .....</b>	<b>176</b>
ACCESSING AF QUICK SETTING .....	176
ADJUSTING THE AF FRAME SIZE .....	176
<b>MF ASSIST FUNCTIONS.....</b>	<b>176</b>
ENLARGEMENT IN AF MODE .....	176
AF ASSIST LAMP .....	177
ACOUSTIC AF CONFIRMATION .....	177
<b>SHIFTING THE AF FRAME.....</b>	<b>177</b>
<b>MANUAL FOCUSING (MF) .....</b>	<b>178</b>
<b>MF ASSIST FUNCTIONS .....</b>	<b>178</b>
ENLARGEMENT IN MF MODE .....	179
<b>MACRO FUNCTION .....</b>	<b>180</b>
<b>ISO SENSITIVITY .....</b>	<b>180</b>
FIXED ISO VALUES .....	180
AUTOMATIC SETTING .....	181
DYNAMIC ISO SETTING .....	182
<b>WHITE BALANCE .....</b>	<b>182</b>
AUTOMATIC CONTROL/FIXED SETTINGS.....	183
MANUAL SETTING VIA METERING .....	183
DIRECT SETTING OF THE COLOR TEMPERATURE .....	184
<b>EXPOSURE .....</b>	<b>184</b>
EXPOSURE METERING METHODS .....	184
EXPOSURE MODES .....	186
SELECTING A MODE .....	186
FULLY AUTOMATIC EXPOSURE SETTING – P .....	187
SEMI-AUTOMATIC EXPOSURE SETTING – A/S .....	187
MANUAL EXPOSURE SETTING – M .....	188
SETTING SHUTTER SPEEDS.....	189
EXPOSURE CONTROL .....	190
EXPOSURE COMPENSATION.....	190
<b>SPECIAL SHOOTING MODES .....</b>	<b>191</b>
DIGITAL ZOOM.....	191

<b>PLAYBACK MODE.....</b>	<b>194</b>
CONTROL ELEMENTS IN PLAYBACK MODE.....	194
DIRECT ACCESS IN PLAYBACK MODE .....	195
CONTROL ELEMENTS ON THE LCD PANEL .....	195
STARTING/EXITING PLAYBACK MODE .....	196
SELECTING/SCROLLING THROUGH RECORDINGS .....	196
INFO DISPLAYS IN PLAYBACK MODE .....	197
DISPLAYING MULTIPLE RECORDINGS AT ONCE .....	198
TAGGING/RATING OF RECORDINGS .....	199
DELETING RECORDINGS .....	200
DELETING INDIVIDUAL RECORDINGS .....	200
DELETING MULTIPLE RECORDINGS.....	201
DELETING ALL UNRATED RECORDINGS .....	202
VIDEO PLAYBACK .....	203
VIDEO EDITING .....	206
<b>OTHER FUNCTIONS.....</b>	<b>208</b>
RESETTING THE CAMERA TO FACTORY SETTINGS .....	208
FIRMWARE UPDATES .....	209
EXECUTING A FIRMWARE UPDATE .....	210
<b>LEICA FOTOS .....</b>	<b>212</b>
SELECTING A WI-FI BAND .....	212
CONNECTIVITY (iPhone users).....	213
FIRST-TIME CONNECTION TO A MOBILE DEVICE .....	213
CONNECTING WITH PAIRED DEVICES.....	214
CONNECTIVITY (Android users) .....	215
FIRST-TIME CONNECTION TO A MOBILE DEVICE .....	215
CONNECTING WITH PAIRED DEVICES.....	216
CONNECTIVITY MODES .....	217
PERFORMANCE MODE .....	218
ECO MODE .....	218
AIRPLANE MODE (Off) .....	218
EXECUTING A FIRMWARE UPDATE.....	218
REMOTE CAMERA CONTROL .....	219
<b>CARE/STORAGE .....</b>	<b>220</b>
PIXEL MAPPING .....	221
<b>FAQ .....</b>	<b>222</b>

MENU OVERVIEW.....	228
TECHNICAL DATA.....	234
LEICA CUSTOMER CARE .....	244
LEICA AKADEMIE .....	244

**Definition of the various categories of information found in this manual**

**Note**

Additional information

**Important**

Failure to comply with instructions may result in damage to the camera, the accessories or the data files

**Attention**

Non-compliance may result in personal injury

# PART DESIGNATIONS

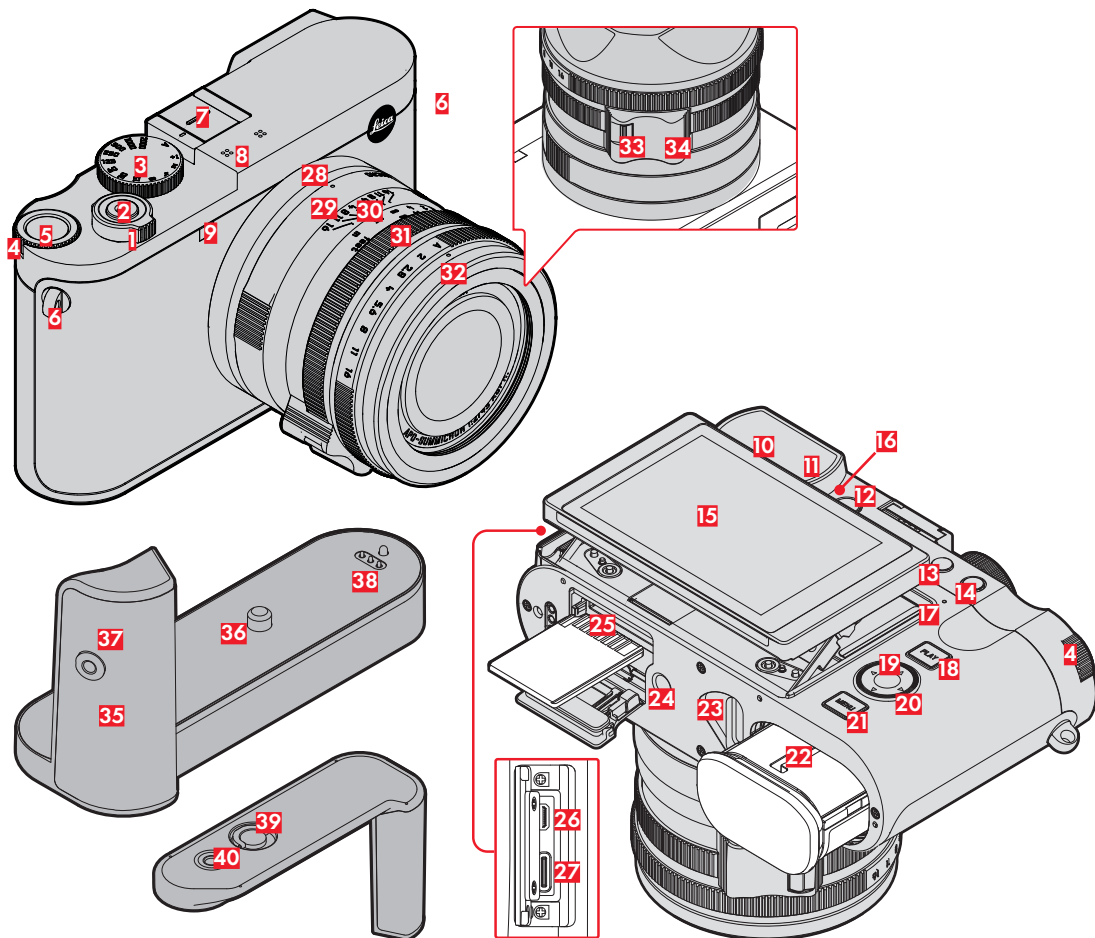

## LEICA Q3 43

- 1** Main switch
- 2** Shutter button
- 3** Shutter-speed dial
- 4** Thumbwheel
- 5** Thumbwheel button
- 6** Strap lugs
- 7** Accessory shoe
- 8** Microphone
- 9** Self-timer LED / AF assist lamp
- 10** Viewfinder eyepiece
- 11** Eye sensor
- 12** Diopter wheel
- 13** FN Button 1 (function button)
- 14** FN Button 2 (function button)
- 15** LCD panel
- 16** Speaker
- 17** Status LED
- 18** **PLAY** button
- 19** Center button
- 20** Directional pad
- 21** **MENU** button
- 22** Battery compartment
- 23** Battery release lever
- 24** Tripod thread
- 25** Memory card slot
- 26** HDMI output
- 27** USB-C output

## LEICA APO-SUMMICRON 43 f/2 ASPH.

- 28** Alignment point for macro function
- 29** Macro ring
- 30** Focus ring
- 31** Aperture ring
- 32** Thread protection ring
- 33** AF/MF lock release
- 34** Focus tab

## LEICA HG-DC1

(optional accessory)

- 35** Handle part
- 36** Locking screw
- 37** Thread for finger loop attachment
- 38** Contact
- 39** Locking toggle
- 40** Tripod thread

## DISPLAYS

The images displayed on the LCD panel and in the viewfinder are identical.

## PHOTO

### CONTROL CENTER

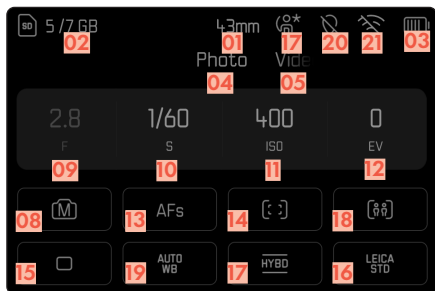

### IN SHOOTING MODE

All displays/values refer to the actual settings.

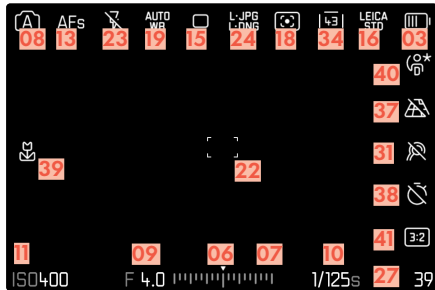

## IN REVIEW MODE

All displays/values refer to the displayed image.

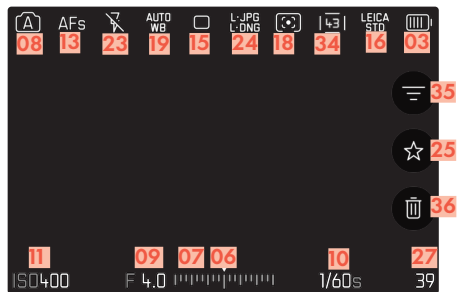

### ACTIVATED Capture Assistants

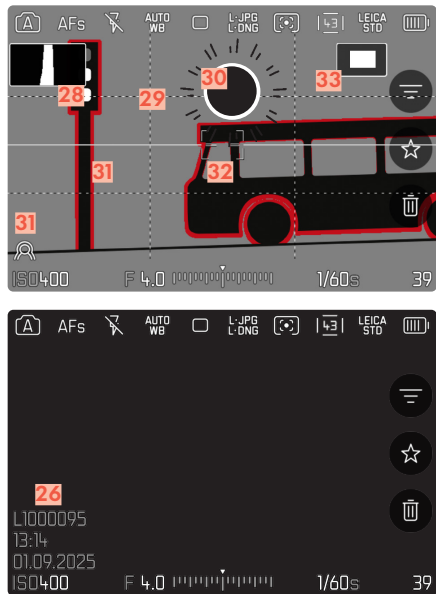

- 01 Focal length/Digital Zoom
- 02 Remaining storage capacity
- 03 Battery capacity
- 04 Menu section PHOTO
- 05 Menu sections VIDEO
- 06 Light balance
- 07 Exposure compensation scale
- 08 Exposure mode
- 09 Aperture value
- 10 Shutter speed
- 11 ISO Sensitivity
- 12 Exposure compensation value
- 13 Focus mode
- 14 AF Mode
- 15 Shooting mode (Drive Mode)
- 16 Leica Looks
- 17 Shutter type
- 18 AF Detection
- 19 White balance
- 20 Geotagging  
Automatic storage of the shooting location (Exif data)
- 21 Leica FOTOS connection
- 22 AF Field
- 23 Flash mode/flash exposure compensation
- 24 File format/compression level/resolution
- 25 Icon for marked picture
- 26 File name
- 27 File number of the image shown
- 28 Histogram
- 29 Grid lines
- 30 Clipping identification of overexposed subject elements
- 31 Focus peaking  
(identification of in sharp edges in the object)
- 32 Level gauge
- 33  Display of cropped section size and position  
(only visible for enlarged sections)
- 34 Digital Zoom Step
- 35 Filter
- 36 Delete
- 37 Perspective Control
- 38 Self-timer
- 39 Macro Function
- 40 User profile
- 41 Aspect ratio

# VIDEO

## CONTROL CENTER

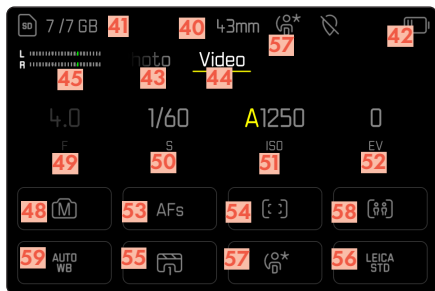

## IN RECORDING MODE

All displays/values refer to the actual settings.

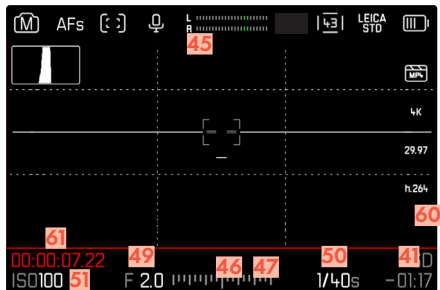

## IN PLAYBACK MODE

All displays/values refer to the displayed image.

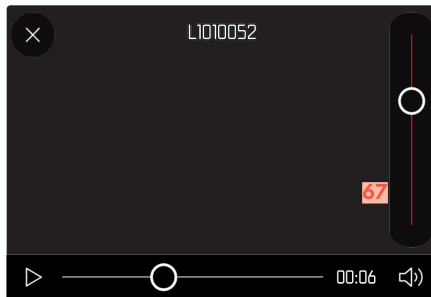
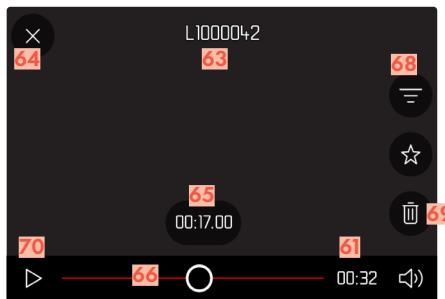
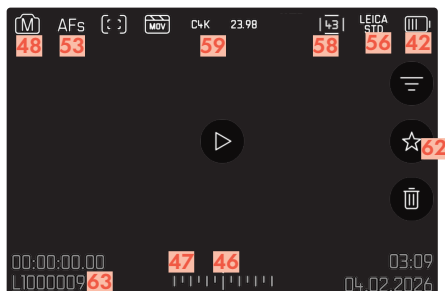







- 40 Focal length/Digital Zoom
- 41 Remaining storage capacity
- 42 Battery capacity
- 43 Menu section **PHOTO**
- 44 Menu sections **VIDEO**
- 45 Microphone recording level
- 46 Light balance
- 47 Exposure compensation scale
- 48 Exposure mode
- 49 Aperture value
- 50 Shutter speed
- 51 ISO Sensitivity
- 52 Exposure compensation value
- 53 Focus mode
- 54 AF Mode
- 55 Video Profiles
- 56 **Leica Looks**
- 57 User profile
- 58 AF Detection
- 59 White balance
- 60 Indicates for video recording in progress 
- 61 Length of video recording
- 62 Icon for marked video recording
- 63 File name
- 64 Exiting video playback
- 65 Current playback time
- 66 Playback status bar
- 67 Volume bar
- 68 Filter
- 69 Delete
- 70 Start playback

## CHARGE STATUS INDICATOR ON THE LCD PANEL

The charge level of the rechargeable battery is displayed in the Control Center and in the header line at the top right.



Display	Charge status
	Approx. 80 – 100%
	Approx. 60 – 79%
	Approx. 40 – 59%
	Approx. 20 – 39%
	Approx. 1 – 19%
	Approx. 0% The battery needs charging or replacing

## PREPARATION

Please read the chapters “Legal information”, “Safety remarks”, and “General information” before using your camera for the first time. Knowledge of the content will prevent inadvertent damage to the product, possible injuries and other risks.

### ATTACHING THE CARRY STRAP

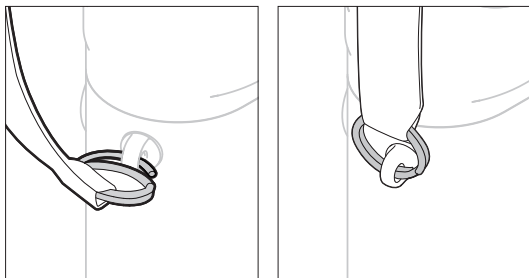

#### Attention

- Once you have attached the carry strap, please make sure that the clips are mounted correctly to prevent the camera from falling.

## PREPARING THE CHARGER BC-SCL4

### (Optional accessory)

Use the mains cable with the matching regional plug to connect the charger to mains electricity.

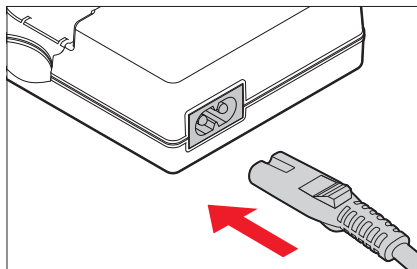

## PREPARING THE CHARGER (LEICA USB-C DUAL CHARGER BC-SCL6)

### (Optional accessory)

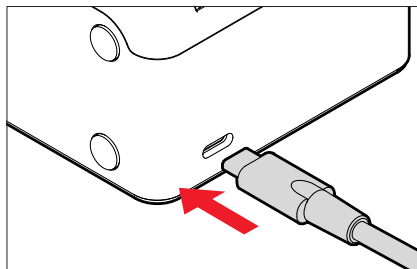

#### Note

- The charger will automatically adapt to local mains voltage.

## CHARGING THE BATTERY

The camera is powered by a lithium-ion battery.

### INSERTING THE BATTERY IN THE CHARGER

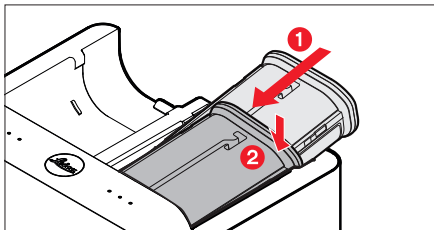
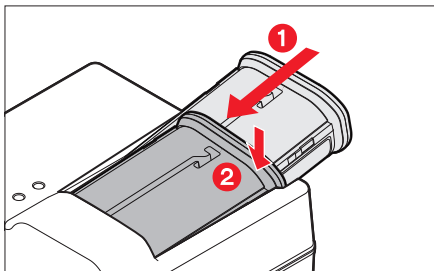

- Slide the battery into the charger with the groove facing up until the contacts meet
- Press down on the battery until you can hear and feel it clicking into place
- Ensure that the battery is fully inserted into the charger

### REMOVING THE BATTERY FROM THE CHARGER

- Tilt the battery up and lift it out at an angle

## CHARGE STATUS INDICATORS ON THE CHARGER

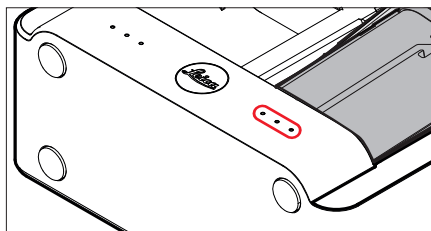
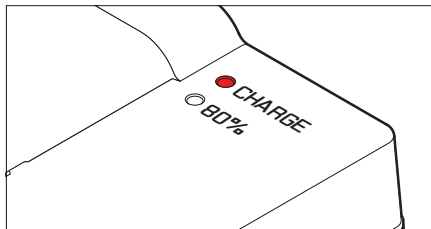

The status LED indicates a correct charging process.

Display	Charge status	Charge time*
•	Battery is charging	
••	80%	Approx. 2 h
•••	100%	Approx. 3.5 h

Disconnect the charger from mains electricity when the charging process is complete. There is no risk of over-charging.

## CHARGING VIA USB

The rechargeable battery in the camera can be automatically charged when the camera is connected to a computer or another suitable power source via USB cable.

Factory setting: **On**

- Select **USB Settings** in the main menu
- Select **USB Charging**
- Select **On/Off**

### Notes

- The camera can be charged while it is switched on. This requires a USB PD-capable power supply unit with an output of min. 9V/3A (27W). Where a power supply unit with an output of less than 27W is used, the camera can only be charged while it is switched off.
- The charging will start automatically.
- For safety reasons, the battery is only minimally charged on delivery. The battery must be activated with an initial charge before first use.



## INSERTING/REMOVING THE BATTERY

- Ensure that the camera is switched OFF (see p. 34)

### INSERTION

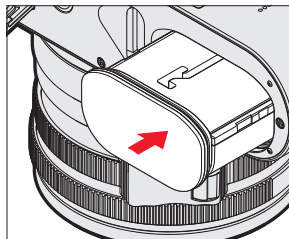

- Insert the battery into the slot with the groove pointing towards the LCD panel and gently push until you hear and feel it clicking into place

## REMOVAL

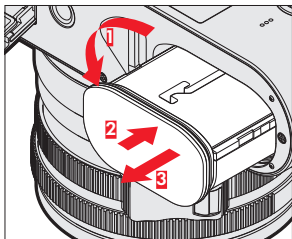

- Turn the battery release lever
  - Battery is pushing out slightly.
- Press down on the battery lightly
  - The battery unlocks and pushes out fully.
- Remove the battery

### Important

- Removing the battery while the camera is switched on may result in the loss of custom settings or damage to the memory card.

## INSERTING/REMOVING THE MEMORY CARD

The camera will save exposures to an SD (Secure Digital), SDHC (High Capacity) or SDXC (eXtended Capacity) memory card.

### Notes

- Various manufacturers offer SD/SDHC/SDXC memory cards in a range of sizes and read/write speeds. Memory cards with high storage capacities and high read/write speeds offer quick storage and rendering.
- The memory card may not be supported (capacity) or will have to be formatted in the camera before first use (see p. 70). The camera will in that case display a relevant message. Please see the section “Technical Data” for information about supported cards.
- Check the memory card for correct alignment if you are having difficulties inserting it into the camera.
- Video shootings require a high write speed.

- Ensure that the camera is switched OFF (see p. 34)

## OPENING THE COVER OVER THE MEMORY CARD SLOT

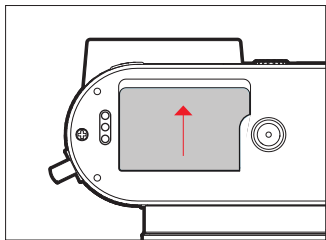

- Slide the cover as shown in the illustration until you hear a click
- The cover lifts automatically.

## CLOSING THE COVER OVER THE MEMORY CARD SLOT

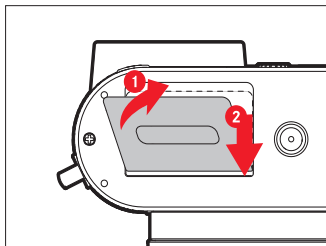

- Close and hold down the cover
- Slide the cover as shown in the illustration until it audibly clicks into place

## INSERTION

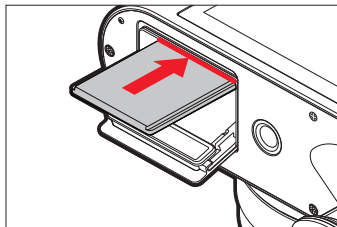

- Push the memory card into the slot with the contacts pointing towards the LCD panel until you hear and feel it clicking into place

## REMOVAL

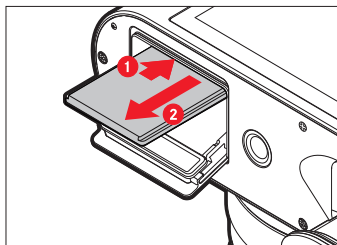

- Push down on the card until you hear a click
- The card pushes out slightly.
- Remove the memory card

## ATTACHING/DETACHING THE LENS HOOD

This camera comes with a matching lens hood. It is pre-mounted ex works.

The use of the lens hood is recommended to reduce vignetting.

### DETACHING

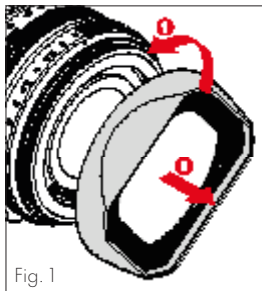

Fig. 1

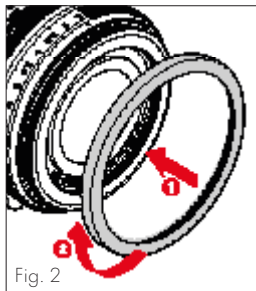

Fig. 2

- Unscrew the lens hood in counter-clockwise direction (Fig. 1)
- Screw on the thread protection ring (Fig. 2)

### Note

- The thread protection ring of the Leica Q3 43 is not compatible with the Leica Q3.

### ATTACHING

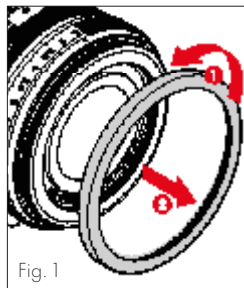

Fig. 1

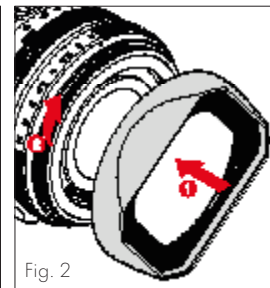

Fig. 2

- Unscrew the thread protection ring in counter-clockwise direction (Fig. 1)
- Screw on the lens hood in clockwise direction to the stop (Fig. 2)

### Notes

- The lens hood cover supplied will only fit the lens hood and cannot be used as lens cover on its own.
- A matching lens front cap E49 (Order No. 14001) is available as an optional accessory for use of the camera without a lens hood:  
<https://store.leica-camera.com>

## DIOPTR SETTINGS

The viewfinder has a diopter setting function with a range between  $-4$  and  $+2$  diopter to allow glasses wearers the use of the camera without eyeglasses (diopter compensation).

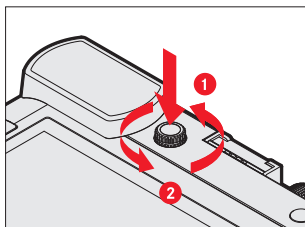

- Push the diopter wheel into its groove until you hear an audible click
  - This unlocks the diopter wheel and it pushes out a little.
- Look through the viewfinder
- Aiming at and focusing on an object
- Push the diopter wheel back into its groove until it audibly clicks into place

## WIRELESS CHARGING HANDGRIP HG-DC1

### (optional accessory)

The HG-DC1, available as optional accessory, ensures optimized handling and expands the camera's charging capabilities. When used with the "Drop XL Wireless Charger – Native Union made for Leica Camera" (Item No. 18899), the camera can be conveniently charged wirelessly at any time. It offers secure and comfortable one-handed operation of the camera. Optionally, a finger strap can be attached (Size L (Item No. 14648), Size M (Item No. 14647), Size S (Item No. 14646)).

## ATTACHING THE HANDGRIP

- Switch off the camera and any attached flash unit
- Attach the handgrip in such a way that the locking screw extends slightly into the tripod thread on the bottom of the camera
- Turn the locking toggle in clockwise direction and tighten it slightly

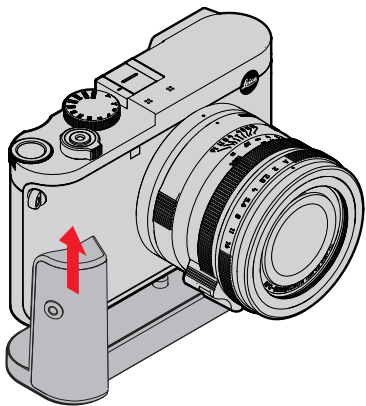

## DETACHING THE HANDGRIP

- Turn the handgrip lock to the left to unlock the connection
  - Make sure to hold the camera and the handgrip securely while doing so.

## WIRELESS CHARGING OF THE CAMERA

- Switch off the camera and any attached flash unit
- Position the camera with the handgrip attached on the charging station
  - Flashing of the status LED on the camera (green, 2 s interval) signifies active charging.

### Notes

- Only charging stations approved for the respective country may be used. Only frequencies permitted in the respective country may be used.
- The charging process will only initiate when the camera is correctly positioned on the charging station.
- Only inductive charging stations with a min. 10 W output can be used.
- Make sure to unplug any attached HDMI and USB cables from the camera before charging.

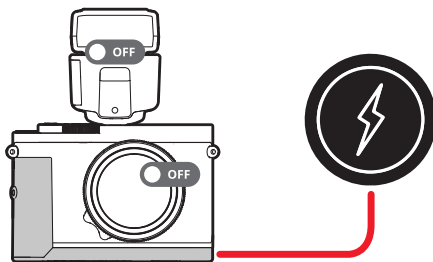

# CAMERA OPERATION

## CONTROL ELEMENTS

### MAIN SWITCH

The main switch switches the camera on and off.

### SWITCHING THE CAMERA ON

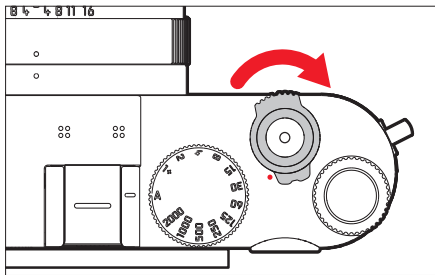

### Notes

- Once switched on, the camera will be ready to use after approx. 1 s.
- The LED lights up briefly and the displays in the viewfinder appear.

### SWITCHING THE CAMERA OFF

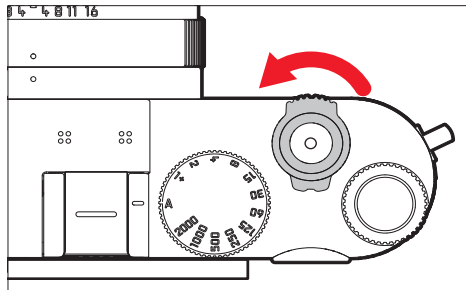

### Note

- The function **Auto Power Off** (see p. 59) deactivates the camera automatically if no operation occurs within a preset time. Use the main switch to deactivate the camera if this function is **Off** to prevent inadvertent exposures and battery discharge when the camera is not in use.

## SHUTTER BUTTON

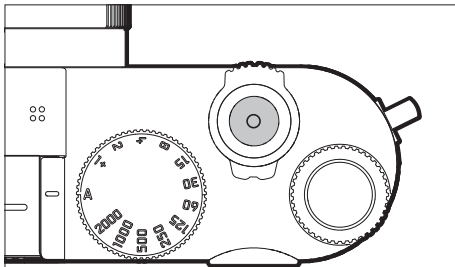

The shutter button works in two stages.

1. **Tapping** (= Pressing the shutter button to the 1st pressure point)
  - Activating the camera electronics and displays
  - Exposure lock (metering & saving):
    - AF mode: range measurement (AF-L)
    - (semi) automatic exposure mode: exposure metering (AE-L)
  - Canceling a running self-timer delay time
  - Return to shooting mode
    - from review mode
    - from menu control
    - following automatic shutdown

## 2. Press down fully

- Shutter release
  - The data is then transferred to the memory card.
- Starting a video shooting
- Initiating a preset self-timer delay time
- Starting a continuous shooting or interval shooting

## Notes

- Press down the shutter button in a smooth motion until you hear the click of the shutter to prevent camera shake.
- The shutter button remains locked:
  - if the memory card inserted and/or the internal buffer memory are (temporarily) full
  - if the battery has exceeded its performance limits (capacity, temperature, age)
  - if the memory card is write-protected or damaged
  - if the sensor is too hot

## SHUTTER-SPEED DIAL

The shutter-speed dial has no stop, which means it can be turned in either direction from any position. It will click at each engraved position and for intermediate values. Intermediate positions outside the click positions must not be used. Please read the section “Exposure” (see p. 98 and 184) for details about correct exposure settings.

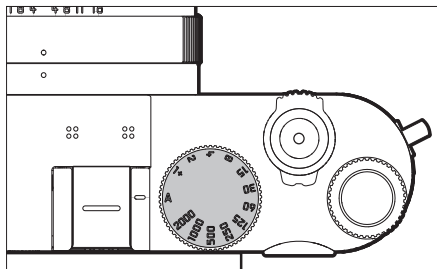

- **A**: aperture-priority mode (Automatic shutter speed control)
- **2000 - 1+**: Fixed shutter speeds

## THUMBWHEEL

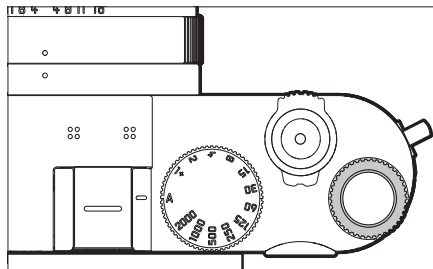

- Menu navigation
- Exposure compensation value selection
- Setting the ISO value
- Enlarging/reducing viewed images
- Setting selected menu items/functions
- Setting the program shift

## THUMBWHEEL BUTTON

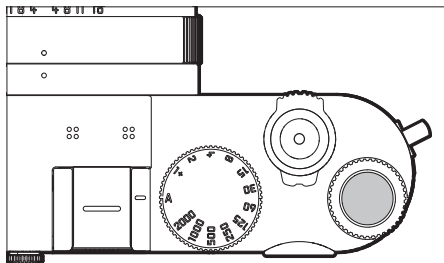

- Applying menu settings
- Direct access to menu functions
- Accessing the submenu

## DIRECTIONAL PAD/CENTER BUTTON

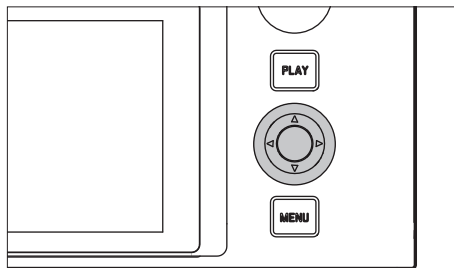

### DIRECTIONAL PAD

- Menu navigation
- Setting selected menu items/functions
- Scrolling through the gallery
- Shifting the focus frame

### CENTER BUTTON

- Accessing the information display
- Accessing the submenu
- Applying menu settings
- Displaying settings/data in shooting mode
- Displaying image data in review mode
- Playback of video recordings
- Confirming the prompts
- Direct access to menu functions

## PLAY BUTTON/MENU BUTTON

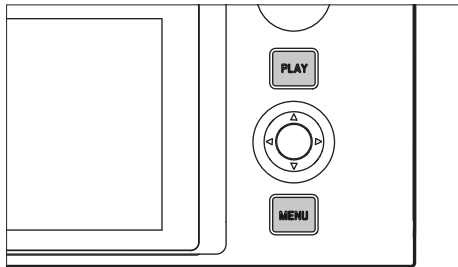

### PLAY BUTTON

- Activation and deactivation of the (continuous) review mode
- Return to full-screen display

### MENU BUTTON

- Accessing the menu (incl. Control Center)
- Accessing the Play menu
- Exiting the currently displayed (sub) menu
- Page-by-page scrolling in the main menu

## LCD PANEL

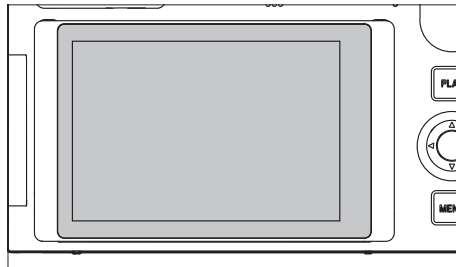

- Displaying most important current settings
- Quick access to some menus
- Touch control

## FOLDING OUT THE SCREEN

The screen can be folded out and up or out and down. A convenient feature for taking pictures from a very low or very high perspective.

The screen folds out in two steps.

### Folding out the screen

- Grasp the screen at the upper edge.
- Carefully fold out the screen along the hinge on the lower edge

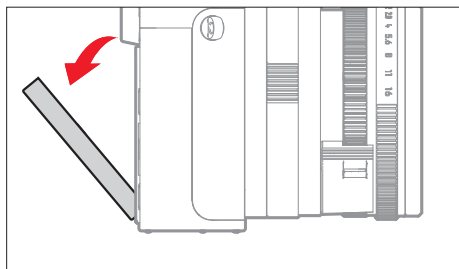
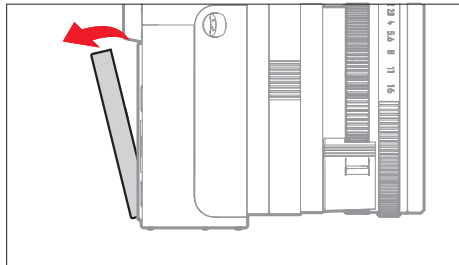

## Aligning the screen

- Once folded out, the screen can be rotated around its center axis to see the desired angle

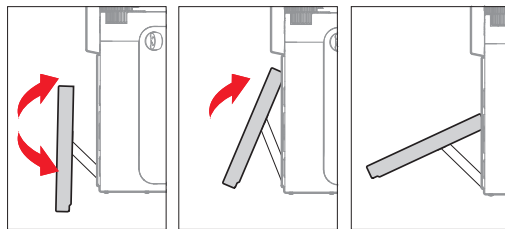

## Folding the screen in

- Swivel the screen downward on its center axis as needed
- Once straight, fold the screen along its hinge on the bottom edge to lie flat against the rear of the camera

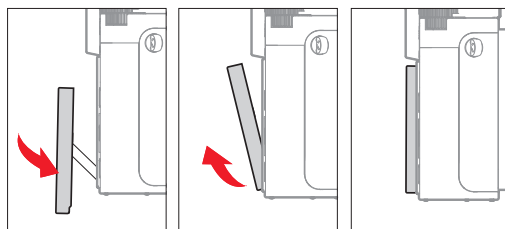



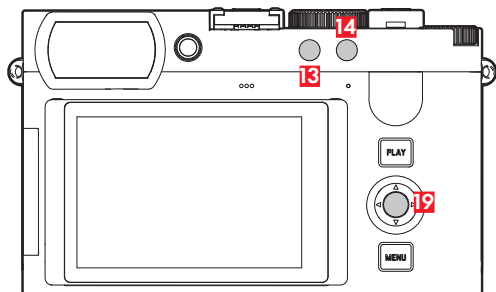
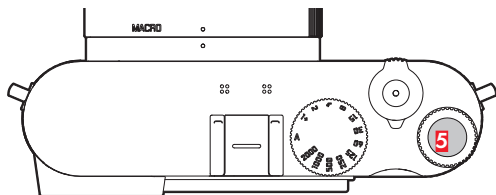





## FUNCTION BUTTONS



Direct access to various menus and functions. All function buttons can be custom configured (see p. 54).

FACTORY SETTINGS	
In shooting mode	In review mode
<b>FN button 1 (13)</b>	
Digital zoom	EVF <> LCD
<b>FN button 2 (14)</b>	
Mode change (photo/video)	Magnification
<b>Thumbwheel button (5)</b>	
ISO settings	Add/Remove
<b>Center button (19)</b>	
Toggle Info Levels	Toggle Info Levels

## LCD PANEL (TOUCH SCREEN)

TOUCH CONTROL*		In shooting mode	In review mode
	"tap"	Shifting the AF frame and focusing (while Touch AF is activated)	Selecting images
	"double tap"	Resetting the AF frame	Enlarging/reducing viewed images
	"swipe"		Scrolling through the gallery Shifts the enlarged image section
	"horizontal swipe" (full length)	Mode change (photo/video)	Scrolling through the gallery
	"vertical swipe" (full length)	Swipe down: Switching to Review mode Swipe up: Switching to Control Center	Switching to shooting mode
	"tap and hold"	Accessing AF Quick Setting & Activating the AF frame size adjustment	
	"two-finger pinch" "two-finger spread"	Changing the size of the AF frame (in specific AF modes, or if AF frame size adjustment is activated)	Enlarging/reducing viewed images
	"swipe and hold" "hold and swipe"		Continuous scrolling

\* A light touch is enough, don't apply pressure.

# MENU CONTROL

## CONTROL ELEMENTS

The following elements are used for menu control.

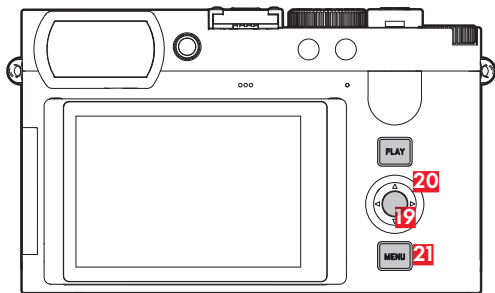
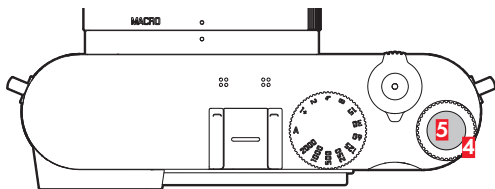

- 4** Thumbwheel
- 5** Thumbwheel button
- 19** Center button
- 20** Directional pad
- 21** MENU button

## MENU SECTIONS

Two menu areas are available: Control Center and Main Menu.

Control Center:

- offers quick access to key settings and the option to rearrange or customize menu items.

Main menu:

- offers access to all menu items
- contains various submenus

The currently active operating mode (Photo or Video) is highlighted in color in all menu areas.

Section	PHOTO	VIDEO
Control Center		
Favorites		
Main menu (top level)	Accent color <hr style="border: 1px solid red;"/>	Accent color <hr style="border: 1px solid yellow;"/>
Main menu (Submenus)		

## CONTROL CENTER

### Photo

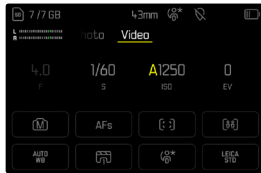

### Video

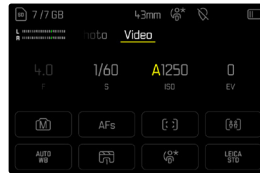

## MAIN MENU

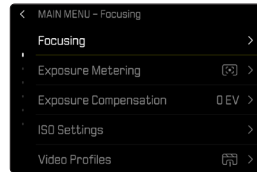
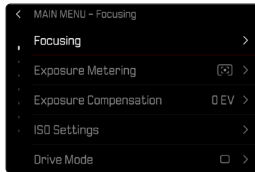

## SETTINGS IN PHOTO AND VIDEO MODE

The available settings depend on the operating mode (Photo or Video) currently in use.

- All menu items and their sub items available in the main menu **before** **Leica FOTOS** are mode-specific. That means that any changes made here, will only apply for the operating mode currently in use. Any menu items of the same name in the other operating mode will be unaffected. This applies to e.g. settings for focusing or exposure metering.
- All settings and functions after that in the main menu (including **Leica FOTOS**) are available in both operating modes and have global effect. A setting selected in one of the modes will also apply to the other.

Settings and functions with global effect are:

- **Leica FOTOS**
- **USB Settings**
- **User Profile**
- **Camera Settings**
- **Camera Information**
- **Language**

## SWITCHING MENU SECTIONS

The Control Center will always be displayed as the first menu section. The top level of the menu is organized into “pages”, which are displayed in the header: Control Center and several sections of the Main Menu. You can switch between menu sections by scrolling through the pages.

### Scrolling forward

- Press the **MENU** button
- or
- Turn the dial in clockwise direction
- or
- Swipe up

### Scrolling backward

- Turn the dial in anti-clockwise direction
- or
- Swipe down
- or
- Press the directional pad left
  - In reverse order, you can only browse back to the Control Center.

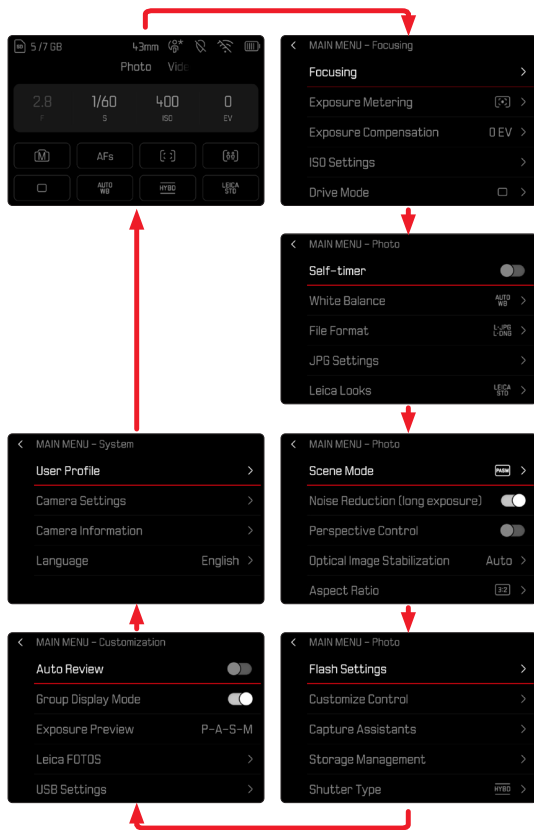

## CONTROL CENTER

The Control Center offers an overview of key data relating to the current camera status and active settings. It furthermore allows direct access to important settings. The Control Center is optimized for touch control.

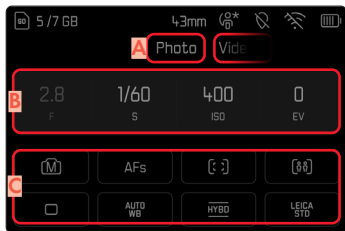

- A** Mode: photo/video (see p. 169)
- B** Exposure settings (see p. 98 and p. 184)
- C** Menu items

### Notes

- Where touch control is not possible or not desirable (e.g. in EVF mode), the Control Center can alternatively be controlled via the directional pad, center button, thumbwheel and the thumbwheel button.
- The settings become effective immediately.
- The framed control panels can be selected. Unframed values are added in automatically (depending on the active exposure mode).
- The available menu items in photo and video mode differ (see p. 22 and p. 24).

## CUSTOMIZING THE CONTROL CENTER

The order of menu items in the Control Center can be customized via touch operation.



Photo	Video
Scene Mode	Scene Mode
Focus Mode	Focus Mode
AF Mode	AF Mode
AF Detection	AF Detection
Drive Mode	White Balance
White Balance	Video Profiles
File Format	Microphone Gain
User Profile	User Profile
Leica Looks	Leica Looks
Exposure Metering	Exposure Metering
iDR	AF Setup
Digital Zoom	iDR
Camera Settings	Log Settings
Shutter Type	ISO Settings
Self-timer	Gray card
Leica FOTOS	Format Storage
Format Storage	Video Gamma
Flash Settings	Optical Image Stabilization
USB Settings	Digital Zoom
Perspective Control	Camera Settings
Aspect Ratio	Leica FOTOS
Optical Image Stabilization	

## SETTINGS

There are a variety of options for changing settings from within the Control Center. The setting types vary from menu to menu.

- Tap the desired control panel
  - The relevant menu appears.

## DIRECT SETTINGS

A version of the menu bar appears in the lower area of the Control Center (see p. 51).

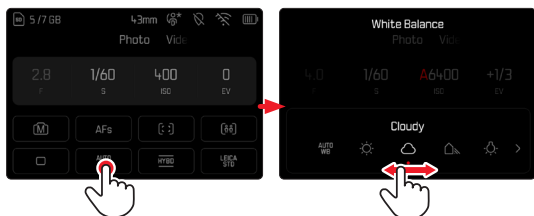

- Select the desired function directly or swipe

## ACCESSING A STANDARD SUBMENU

These menus behave as if they were accessed from within the main menu (see p. 48). Touch control is therefore unavailable. From there, you are returned to the Control Center and not the previous menu item.

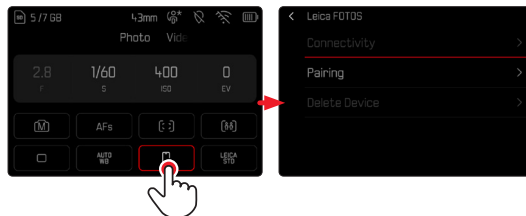

- Select the desired setting

## MAIN MENU

The main menu offers access to all settings. Most of these are organized in submenus.

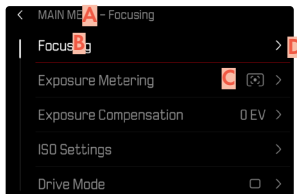

- A** Menu section: `Main Menu`
- B** Menu item name
- C** Menu item setting
- D** Submenu reference

## SUBMENU

There are various types of submenus available. The following pages describe their operation.

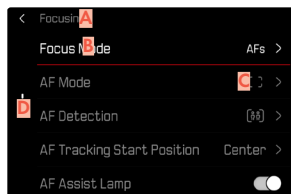

- A** Current menu item
- B** Submenu item
- C** References to other submenus
- D** Scrollbar

## MENU NAVIGATION

### SCREEN BY SCREEN NAVIGATION

#### Using button control

#### Scrolling forward

- Press the **MENU** button (repeatedly if needed)
  - The Control Center will reappear after the last page of the Main Menu was displayed.

#### Scrolling backward

- Press the directional pad left
  - In reverse order, you can only browse back to the Control Center.

#### Using touch control

- Swiping or moving on the scrollbar

## LINE BY LINE NAVIGATION

(Function/function option selection)

- Press the directional pad up/down

or

- Turn the thumbwheel  
(to the right = down, to the left = up)
  - Once the last menu item has been reached scrolling up or down, the display will automatically jump to the previous or next screen. The currently active menu section (Favorites, Main Menu) is not exited.

#### Note

- The preset values of any menu items that cannot be modified will be grayed out.

## SHOW SUBMENU

- Press the center button/thumbwheel button
- or
- Press the directional pad to the right

## CONFIRM SELECTION

- Press the center button/thumbwheel button
  - The screen image changes back to the active menu item. The set function variant is shown on the right in the relevant menu line.

### Note

- No confirmation is needed for the selection of **On** or **Off**. An automatic save is done.

## GO BACK ONE STEP

### (Return to the superordinate menu item)

- Press the directional pad left
  - This option is only available for list-type submenus.

## GO BACK TO TOP MENU LEVEL

- Press the **MENU** button 
- The top level of the currently selected menu section is displayed.

## EXITING THE MENU

You can exit the menus and submenus at any time – with/without applying the settings selected there.

### Go to shooting mode

- Tap the shutter button

### Go to review mode

- Press the **PLAY** button

## SUBMENU

### KEYBOARD/NUMBER PAD



- A** Entry line
- B** Keyboard/Number pad
- C** "Delete" button (deletes the last character entered)
- D** "Confirm" button (to apply individual values and existing settings)
- E** Return to previous menu level
- F** Shift key (toggles between upper and lower case letters)
- G** Changing the character type

## SELECTING A BUTTON (ICON/FUNCTION BUTTON)

### Using button control

→ Press the directional pad in the relevant direction

- The currently active button will be highlighted.

→ Press the center button/thumbwheel button

or

→ Turn the thumbwheel

- The currently active button will be highlighted.
- There will be an automatic jump to the next/previous line when the end/beginning of the line is reached.

→ Press the center button/thumbwheel button

### Using touch control

→ Press the button of your choice

## SAVE

→ Select button **D**

## CANCEL

→ Select button **E**

## MENU BAR

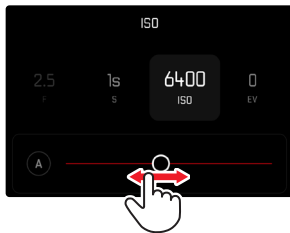

### Using button control

- Press the directional pad left/right
- or
- Turn the thumbwheel

### Using touch control

- Select the desired function directly or swipe

### Notes

- The set value is displayed above the scale/below the menu bar.
- The following applies for direct access: The selected function requires no additional confirmation and will be active immediately.

## SCALE MENU

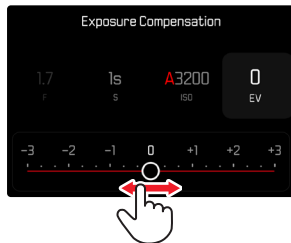

### Using button control

- Press the directional pad left/right
- or
- Turn the thumbwheel

### Using touch control

- Select the desired setting directly or swipe

### Notes

- The set value is displayed above the scale/below the menu bar.
- The following applies for direct access: The selected function requires no additional confirmation and will be active immediately.

## DATE/TIME MENU

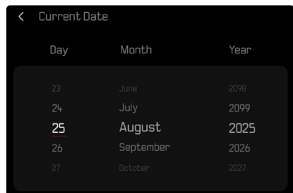

### Moving to the next settings field

→ Press the directional pad left/right

### Setting values

→ Press the directional pad up/down

or

→ Turn the thumbwheel

### Saving and returning to superordinate menu item

→ Press the center button

## COMBI MENU (LEICA LOOKS)

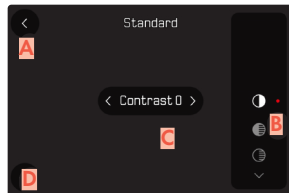

**A** "Back" button  
(Exit without saving)

**B** "Parameter" button

**C** "Setting" button

**D** "Confirm" button  
(Save and exit)

The operation is slightly different, depending on whether the settings are done via key control or touch control. The screen image will remain visible continuously while settings are being adjusted. The result of the setting can be observed directly.

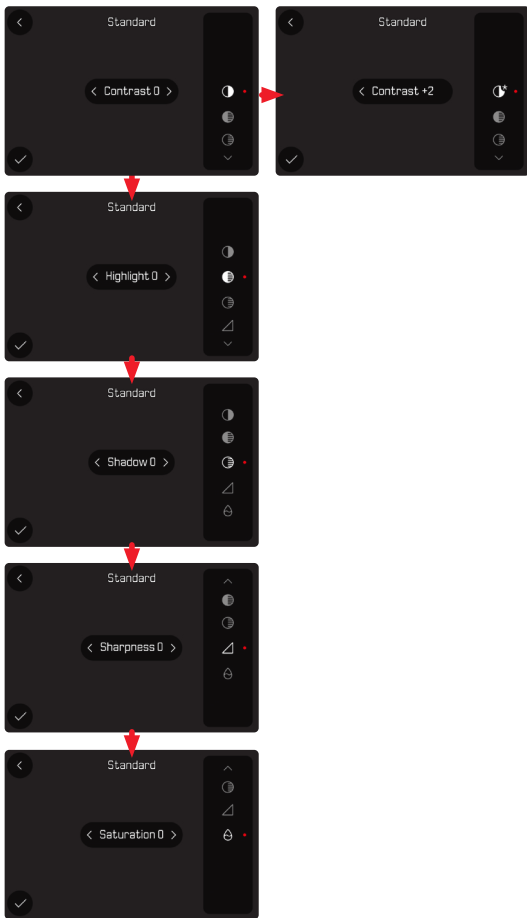

## Using button control

### Navigating between buttons

- Press the directional pad up/down
  - The relevantly active button is indicated by a red dot.

### Applying setting

- Press the directional pad left/right
  - The button toggles directly between each of the options.

or

- Press the center button
  - All selectable options are displayed.
  - The "Parameter" button displays the currently set value for each of the parameter options.
- Press the directional pad up/down
  - The relevantly active button is indicated by a red dot.
- Press the center button
  - The options are no longer displayed.

## Using touch control

- Tap the desired button
  - All available options are displayed for the buttons "Parameter" and "Setting".
  - The "Parameter" button displays the currently set value for each of the parameter options.
- Tap the desired alternative

### SAVE

- Select the "Confirm" button

### CANCEL

- Select the "Back" button

## USER-DEFINED OPERATION

### DIRECT ACCESS TO MENU FUNCTIONS

You can assign specific menu functions to the function buttons for extra quick direct access to menu items in shooting mode.

The Control Center can be customized to allow quick access to a selected function. See p. 45 for more information.

The assignments in photo and video mode are completely independent of each other. The available functions are shown in the list on p. 228. For factory settings see p. 40.

#### Notes

- The submenus accessed via direct access may look differently than when they are accessed via the main menu. Specifically, they often appear as menu bars to allow quick settings.
- The settings can be done via key control or using touch control on the LCD panel. The operating mode depends on the type of submenu.

### CHANGING AN ASSIGNMENT

All function buttons permit a quick and easy reassignment of functions in addition to access to their currently assigned menu function.

- Switch to the desired mode (photo or video)
- Press and hold the desired function button
  - The direct access appears on the LCD panel.
- Select the desired menu item

#### Note

- Custom function button assignments can be saved in user profiles.

### ACCESSING THE ASSIGNED MENU FUNCTION

- Briefly press and release the desired function button
  - The assigned function is accessed, or a submenu appears on screen.

### CREATING THE CUSTOM LIST

- Switch to the desired mode (photo or video)
- Select Customize Control in the main menu
- Select FN Button 1/FN Button 2/Center Button/Thumbwheel Button
- Select On or Off for each menu item

## THUMBWHEEL ASSIGNMENT

In factory settings, the thumbwheel function depends on the active exposure mode. However, the thumbwheel can also be assigned another function.

- Switch to the desired mode (photo or video)
- Select **Customize Control** in the main menu
- Select **Thumbwheel**
- Implementing the desired assignment

	Thumbwheel
P	<b>Program shift</b> Exposure compensation ISO
S	<b>Exposure Compensation</b> Shutter speed ISO
A	<b>Aperture</b> Exposure compensation ISO
M	<b>Aperture</b> Shutter speed ISO

## ACCESSING THE ASSIGNED MENU FUNCTION

- Turn the thumbwheel to the left/right

## LOCKING THE DIAL

- Select **Customize Control** in the main menu
- Activate **Dial Lock**

### Note

-  appears on screen when a operating element is used while the lock is active.

## USER PROFILES

This camera allows the permanent storage of any menu settings, to e.g. access them quickly and easily for recurring conditions/image objects. The camera will also save the currently selected mode (Photo/Video).

Six memory slots are provided to store custom settings, plus the factory setting, which is always available and cannot be modified (**Default Profile**). You can assign names for the saved profiles yourself.

Any profiles configured for the camera can be saved to a memory card for use on another Leica Q3 43. Similarly, profiles saved on a memory card can be transferred to the camera.

Only profiles of the same camera series can be used. Leica Q3 43 profiles can therefore not be used on a Leica Q3 or Leica Q3 Monochrome.

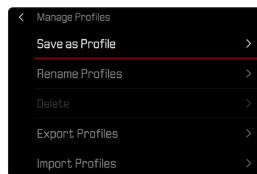
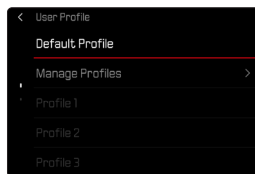

The following information will be saved to the user profiles:

- All settings in Photo and Video mode
- Function button assignments in Photo and Video mode
- All custom Control Center settings

Leica FOTOS settings will not be saved.

## CREATING PROFILES

Saving settings/creating a profile.

- Create custom settings for the desired functions via menu control
- Select **User Profile** in the main menu
- Select **Manage Profiles**
- Select **Save as Profile**
- Select a memory slot

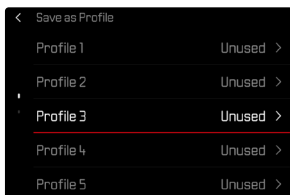

- Confirm the selection

### Note

- Existing profiles are overwritten with the latest settings.

## RENAMING PROFILES

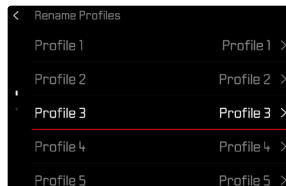

- Select **User Profile** in the main menu
- Select **Manage Profiles**
- Select **Rename Profiles**
- Select a profile
- Enter a name for the profile via the associated sub-menu keyboard and confirm your input (see p. 50)
  - Profile names must be between 3 and 10 characters in length.

## APPLYING/ACTIVATING PROFILES

Factory setting: **Default Profile**

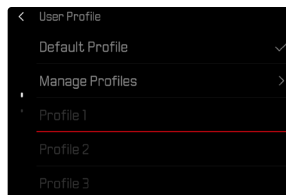

- Select **User Profile** in the main menu
  - A list of profile names is displayed.
- Select a profile
  - The selected profile is marked as .
  - Free memory slots appear in gray.

## DELETING PROFILES

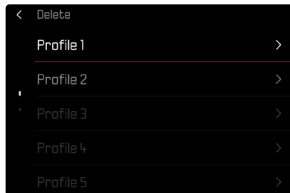

- Select **User Profile** in the main menu
- Select **Manage Profiles**
- Select **Delete**
- Select a profile
- Confirm the selection

## EXPORTING/IMPORTING PROFILES TO/FROM THE MEMORY CARD

- Select **User Profile** in the main menu
- Select **Manage Profiles**
- Select **Export Profiles** or **Import Profiles**
- Confirm the selection

### Notes

- When importing and exporting, all profile slots are transferred to the card, i.e. including any empty slots. Any existing profiles stored in the camera will be overwritten, during the profile import. Individual profiles cannot be imported or exported.
- Any existing set of profiles will be replaced on the memory card during an export without an acknowledgment prompt.

## CAMERA BASIC SETTINGS

The menu items **Language** and **Date & Time** appear automatically when switching the camera on for the first time for setup.

### MENU LANGUAGE

Factory setting: English

Available menu languages: German, French, Italian, Spanish, Portuguese, Russian, Japanese, Korean and Traditional or Simplified Chinese

- Select **Language** in the main menu
- Select your language
  - Aside from a few exceptions, the language will be changed for all information.

## DATE/TIME

### DATE

You can choose one of 3 options for the display sequence.

- Select **Camera Settings** in the main menu
- Select **Date & Time**
- Select **Date Setting**
- Select the desired date format  
(**Day/Month/Year**, **Month/Day/Year**, **Year/Month/Day**)
- Set the date

### TIME

- Select **Camera Settings** in the main menu
- Select **Date & Time**
- Select **Time Setting**
- Select the desired brightness  
(**12 Hours**, **24 Hours**)
- Set the time  
(Select **am** or **pm** for the 12-hour format)

## TIME ZONE

- Select **Camera Settings** in the main menu
- Select **Date & Time**
- Select **Time Zone**
- Select your time zone/current location
  - The Greenwich Mean Time offset is shown on the left of the line
  - Major cities in the relevant time zones are shown on the right

## DAYLIGHT SAVING TIME

- Select **Camera Settings** in the main menu
- Select **Date & Time**
- Select **Daylight Saving Time**
- Select **On/Off**

## POWER SAVE MODE (AUTO POWER OFF)

The camera will automatically shut down to extend battery life if this function is activated.

The device has two power save levels.

- Activation of the auto power off function after 30 s/1 min/2 min/5 min/10 min
- Automatic LCD panel shutdown (see p. 62)

Factory setting: **2 min**

- Select **Camera Settings** in the main menu
- Select **Power Saving**
- Select **Auto Power Off**
- Select the desired setting  
(**30 s**, **1 min**, **2 min**, **5 min**, **10 min**)

### Note

- The camera can be reactivated by pressing the shutter button even if it was automatically shut down.

## LCD PANEL/VIEWFINDER SETTINGS

The camera comes equipped with a 3" liquid crystal color panel, which is protected by a glass cover made of extremely hard and scratch-resistant glass.

The following functions can be configured and used individually:

- Use of the LCD panel and EVF (electronic viewfinder)
- Eye sensor sensitivity
- Brightness
- Color rendering
- EVF Frame Rate
- Automatic LCD panel and EVF shutdown

## LCD PANEL/EVF USE

You can preset the situations in which EVF and LCD panel should be used. The displays appearing on screen and in the electronic viewfinder are identical.

The setting toggles to **LCD** automatically when the screen is folded out. The original setting resumes, once the screen is folded back in.

Factory setting: **Auto**

	EVF	LCD panel
LCD		<ul style="list-style-type: none"><li>• Shooting</li><li>• Review</li><li>• Menu control</li></ul>
Auto	The eye sensor in the viewfinder automatically toggles the camera between LCD panel and EVF. <ul style="list-style-type: none"><li>• Shooting</li><li>• Review</li><li>• Menu control</li></ul>	
EVF extended	Only EVF is used for shooting mode. The eye sensor in the viewfinder automatically toggles the camera between LCD panel and EVF for review and menu control. <ul style="list-style-type: none"><li>• Shooting</li><li>• Review</li><li>• Menu control</li></ul>	
EVF	<ul style="list-style-type: none"><li>• Shooting</li><li>• Review</li><li>• Menu control</li></ul>	

- Select **Camera Settings** in the main menu
- Select **Display Settings**
- Select **EVF <> LCD**
- Select the desired setting

#### Note

- Select **EVF** if you want to keep the LCD panel switched off (e.g. on dark environments).

## EYE SENSOR SENSITIVITY

You can adjust the eye sensor sensitivity to ensure that the changeover functions reliably if you wear eyeglasses.

Factory setting: **High**

- Select **Camera Settings** in the main menu
- Select **Display Settings**
- Select **Eye Sensor Sensitivity**
- Select the desired setting

## BRIGHTNESS

You can adjust brightness for best visibility in various lighting conditions. Brightness is set individually for the LCD panel and the viewfinder. Selection occurs via key control or touch control.

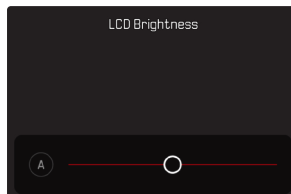

## LCD PANEL

- Select **Camera Settings** in the main menu
- Select **Display Settings**
- Select **LCD Brightness**
- Select the desired brightness or **Auto**
- Confirm selection

## EVF

- Select **Camera Settings** in the main menu
- Select **Display Settings**
- Select **EVF Brightness**
- Look through the viewfinder
- Select the desired brightness
- Confirm selection

#### Note

- The setting **Auto** is not available here.

## COLOR RENDERING

Color rendering can also be adjusted. Brightness is set individually for the LCD panel and the viewfinder. Selection occurs via key control or touch control.

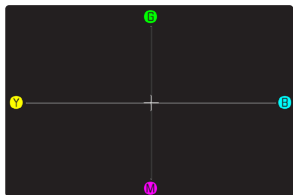

## LCD PANEL

- Select **Camera Settings** in the main menu
- Select **Display Settings**
- Select **LCD Color Adjustment**
- Select the desired color setting
- Confirm selection

## EVF

- Select **Camera Settings** in the main menu
- Select **Display Settings**
- Select **EVF Color Adjustment**
- Look through the viewfinder
- Select the desired color setting
- Confirm selection

## AUTOMATIC LCD PANEL AND EVF SHUTDOWN

The LCD panel and EVF deactivate automatically to save power. The time until power off can be set.

This setting also affects autofocus; the AF system will be deactivated at the time of automatic shutdown as well. We therefore recommend the **Off** setting if autofocus is to be used in HDMI recordings.

Factory setting: **1 min**

- Select **Camera Settings** in the main menu
- Select **Power Saving**
- Select **Displays/AF Auto Off**
- Select the desired setting  
(**30 s**, **1 min**, **5 min**)

## EVF FRAME RATE

The image frequency of the EVF can be set.

Factory setting: **60 fps**

- Select **Camera Settings** in the main menu
- Select **Display Settings**
- Select **EVF Frame Rate**
- Select the desired setting  
(**60 fps**, **120 fps**)

## ACOUSTIC SIGNALS

Some functions can be acknowledged with acoustic signals. The following special functions can be configured separately:

- Electronic shutter sound
- AF confirmation

## VOLUME

The volume of active signals can be set.

Factory setting: **Low**

- Select **Camera Settings** in the main menu
- Select **Acoustic Signal**
- Select **Volume**
- Select **Low/High**

## NOTIFICATION SIGNALS

This setting specifies, whether the camera shout output general notification signals, e.g. during the delay time of the self-timer or as a warning signal, when the memory card is full.

Factory setting: **Off**

- Select **Camera Settings** in the main menu
- Select **Acoustic Signal**
- Select **Notification Signals**
- Select **On**

## ELECTRONIC SHUTTER SOUND

Factory setting: **Off**

- Select **Camera Settings** in the main menu
- Select **Acoustic Signal**
- Select **Electronic Shutter Sound**
- Select **On**

## AUTOFOCUS CONFIRMATION

A signal sound can be selected for successful AF settings.

Factory setting: **Off**

- Select **Camera Settings** in the main menu
- Select **Acoustic Signal**
- Select **AF Confirmation**
- Select **On**

## SILENT PHOTOGRAPHY

When pictures should be taken as quietly as possible.

- Select **Camera Settings** in the main menu
- Select **Acoustic Signal**
- Select **Electronic Shutter Sound/AF Confirmation/Notification Signals**
- Select **Off** for each of these menu items

# STILL IMAGE SETTINGS

## FILE FORMAT

Choose the format JPG or the standardized raw data format DNG (= digital negative). Both can be used individually or simultaneously.

### JPG

When creating JPGs, an initial processing occurs in the camera. Various parameters, including contrast, saturation, black level, or edge sharpness are set automatically. The result is then compressed and stored. The immediate result is an image that is optimized for various uses and a quick preview.

When JPG image mode is selected, images can be captured in a choice of 3 resolutions (number of pixels). This choice allows an alignment with the intended use and available memory card capacity.

When the Digital Zoom function (see p. 116) is selected, then images will be saved with the following actual resolutions.

Digital Zoom	JPG Resolution		
	L-JPG	M-JPG	S-JPG
Off (43 mm)	60 MP	36 MP	18 MP
60 mm	31 MP	19 MP	9 MP
75 mm	20 MP	12 MP	6 MP
90 mm	14 MP	8 MP	4 MP
120 mm	8 MP	5 MP	2 MP
150 mm	5 MP	3 MP	2 MP

### DNG

For post-processing, on the other hand, DNG images are recommended. DNG files contain all raw data as recorded by the camera sensor at the time the photo is taken. Special software (e.g. Adobe® Photoshop® Lightroom® or Capture One Pro®) will be needed to display DNG format files or to work with this format. Post-processing will allow exact adjustments of many parameters to your own expectations.

Three different resolutions (number of pixels) are available for shooting in raw data format (DNG). All the benefits of DNG capture (like extensive color depth and high dynamic range) can therefore be used even if the image size is reduced.

## SETTING THE FILE FORMAT

Factory setting: **L-DNG / L-JPG**

→ Select **File Format** in the main menu

→ Select a format

**(L-DNG, M-DNG, S-DNG, L-DNG / L-JPG, L-DNG / M-JPG, L-DNG / S-JPG, M-DNG / L-JPG, M-DNG / M-JPG, M-DNG / S-JPG, S-DNG / L-JPG, S-DNG / M-JPG, S-DNG / S-JPG, L-JPG, M-JPG, S-JPG)**

### Note

- The remaining number of shots shown in the LCD panel will not necessarily change after every shooting. That very much depends on the object; very fine image structures result in higher data quantities, while homogeneous surfaces mean less data.

## ASPECT RATIO

You have a choice of aspect ratios to select in addition to the basic 3:2 (e.g. 1:1). The relevant cropped section will be displayed. Images made in JPG format are saved with the relevant aspect ratio. DNG images will always have the natural sensor format (3:2), the set aspect ratio is only in aid of the image composition. In review mode, DNG images will be displayed with horizontal or vertical auxiliary lines showing the cropped section seen when shooting.

Factory setting: 3:2

- Select **Aspect Ratio** in the main menu
- Select the desired setting  
(3:2, 4:3, 1:1, 16:9)

## LEICA LOOKS

The image properties of pictures can easily be changed using a variety of parameters. These are summarized in pre-configured **Leica Looks** profiles. Furthermore, additional Leica Looks can be downloaded and transferred via Leica FOTOS.

Pre-installed are:

- **Standard**
- **Vivid**
- **Natural**
- **Monochrome**
- **Monochrome High Contrast**

- Select **Leica Looks** in the main menu
- Select a profile

## CUSTOMIZING LEICA LOOKS

Leica Looks are individually customizable.

### LOOKS CONFIGURATION FRAME

Customizable	Only intensity	Not customizable
<b>Core Looks</b> (Standard, Vivid, Natural, Monochrome, Monochrome High Contrast)	<b>Essential Looks</b> (Teal, Chrome, Eternal etc.)	<b>Artist or Partner Looks</b> (Greg Williams)

### Note

- This information may change with the addition of new Leica Looks.

- Select **Leica Looks** in the main menu
- Select a profile
- Select **Customize**
- Select **Contrast/Highlight/Shadow/Sharpness/Saturation**
- Select the desired level  
(-2, -1, 0, +1, +2)
- **Intensity** can be set as a percentage as needed

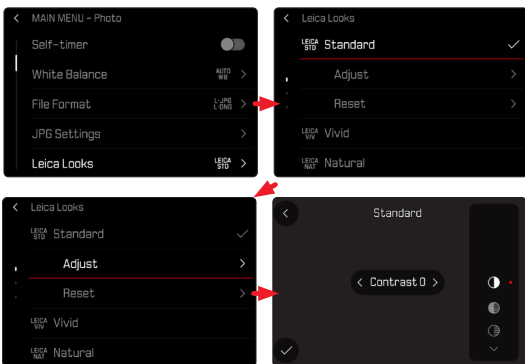

## DOWNLOADING LEICA LOOKS

Additional Leica Looks can be downloaded and transferred via Leica FOTOS.

- Select **Leica Looks** in the main menu
- Select **Download Leica Look**

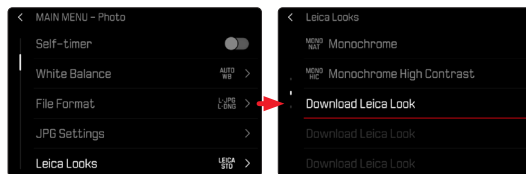

## RESETTING LEICA LOOKS

- Select **Leica Looks** in the main menu
- Select **Restore**

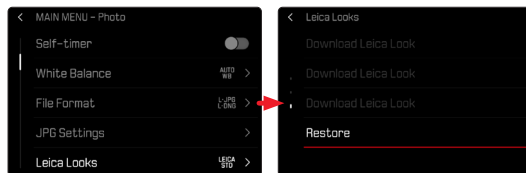

### Note

- Only customizable Leica Looks can be reset.

# AUTOMATIC OPTIMIZATION

## NOISE REDUCTION

### NOISE REDUCTION FUNCTION FOR LONG-TERM EXPOSURE

In digital photography, the appearance of flawed pixels that can be white, red, blue or green is referred to as "noise". Image noise becomes more apparent when using higher sensitivities, particularly on uniform dark areas. Long exposure times may cause severe image noise. In order to reduce this annoying phenomenon, the camera will take a second "dark frame" (taken with the shutter closed) automatically after a shooting with slow shutter speed and high ISO value. The noise metered in this parallel shot will then be "subtracted" digitally from the data for the actual shot. In such cases the message **Noise reduction in progress...** will appear with a relevant time value.

This "exposure time" doubling must be taken into account in long-term exposures. The camera must not be switched off during that time. We recommend disabling Noise Reduction to allow shooting multiple frames in series and to apply noise reduction later during the post-editing stage. The images will have to be taken in raw data format.

Factory setting: **On**

- Select **Noise Reduction (long exposure)** in the main menu
- Select **On/Off**

Under certain conditions, noise reduction will always be active as long as the function is enabled. That includes shots taken with the T function, as well as long-term exposure frames with shutter speeds of approx.  $\geq 8$  s.

In all other cases, noise reduction depends on a combination of factors (specifically ISO setting, exposure time, and sensor temperature). The following table contains a list of shutter speeds typical for a sensor temperature of 25°C, at which noise reduction would be applied.

ISO	Shutter speed longer than
100	7 s
200	6.4 s
400	5.9 s
800	5.4 s
1600	4.9 s
3200	4.5 s
6400	4.2 s
$\geq 12500$	3.8 s

## NOISE REDUCTION IN JPG IMAGES

Except when high sensitivities are used, noise is luckily negligible. Nevertheless, noise reduction is a component of data processing when JPG files are generated. On the other hand, since it also has an effect on the focus review, you can optionally weaken or strengthen this noise reduction in comparison to the standard setting.

Factory setting: **Low**

- Select **JPG Settings** in the main menu
- Select **Noise Reduction (JPG)**
- Select the desired setting  
(**High**, **Standard**, **Low**)

### Note

- This setting will only affect images in JPG format.

## OPTICAL IMAGE STABILIZATION

The less favorable the lighting conditions during shooting, the slower will be the required shutter speeds for correct exposure. Visual image stabilization is a great tool for preventing out-of-focus images due to blurring.

Factory setting: **Auto**

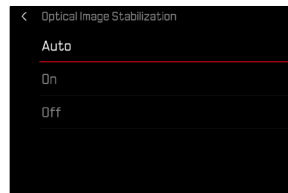

- Select **Optical Image Stabilization** in the main menu
- Select the desired setting  
(**Auto**, **On**, **Off**)
  - With **Auto** selected, Optical Image Stabilization will be activated in the following situations:
    - where shutter speeds of more than 1/60 s are set
    - while the shutter button is pressed down fully

## DARK AREA OPTIMIZATION (IDR)

### DYNAMIC RANGE

The contrast range of an object comprises all levels of brightness from the brightest to the darkest point in the image. All levels of brightness can be captured by the sensor, provided the contrast range of the object is lower than the dynamic range of the camera. In case of significant differences of brightness in the object (e.g. shootings of interior spaces with bright windows in the background, shootings with subject elements in shadow or directly lit by the sun, landscapes with dark areas and a very bright sky), the camera with its limited dynamic range will not be able to map the entire contrast range of the object. Information in 'edge areas' will be lost (under and overexposure).

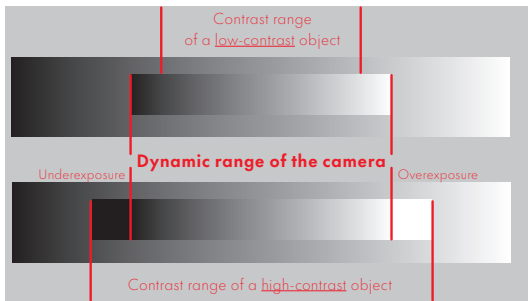

### IDR FUNCTION

The **IDR** (Intelligent Dynamic Range) function allows an optimization of the darker areas. Object details become much clearer. This function will only affect images in JPG format.



You can specify beforehand if and to what extent you want to optimize darker areas (**High**, **Standard**, **Low**, **Off**). In the **Auto** setting, the camera will automatically select the right setting depending on the contrast range of the object. In addition to that setting, the effect also depends on the exposure settings. The function will have the strongest effect in combination with low ISO values and fast shutter speeds. The effect is less pronounced with higher ISO values and/or slower shutter speeds.

Factory setting: **Auto**

- Select **JPG Settings** in the main menu
- Select **IDR**
- Select the desired setting (**Auto**, **High**, **Standard**, **Low**)

### Notes

- The optimization of darker areas will slightly reduce differentiation in very bright areas.
- This function will only affect images in JPG format.

## DATA MANAGEMENT

### FORMATTING A MEMORY CARD

Memory cards that have already been in use with this camera will usually not require formatting. An unformatted memory card that is inserted into the camera for the first time must be formatted. We recommend formatting memory cards from time to time, because residual data traces (data pertaining to individual shots) may reduce the card's memory capacity.

- Select **Storage Management** in the main menu
- Select **Format Storage**
- Confirm the selection
  - The status LED will flash during the process.

#### Notes

- Never switch off the camera while data transfer is in progress.
- All data stored on the memory card will be lost during formatting. Formatting will not be prevented by a deletion protection set for individual shots.
- All images should therefore be regularly transferred to a safe mass storage medium, e.g. the hard disk of a computer.
- A simple formatting process will initially not irretrievably destroy existing data on the card. Only the directory will be deleted, which means the data will no longer be directly accessible. Data access can be restored with appropriate software. Only data that is overwritten when new data is saved will actually be irretrievable.
- A memory card should be formatted again in the camera if it was formatted in another device, e.g. a computer.
- Contact your retailer or Leica Customer Care for assistance if the memory card cannot be formatted/overwritten (see p. 244).

## DATA STRUCTURE

### FOLDER STRUCTURE

The files (= photos) on the memory cards are saved in automatically generated folders. The first three characters signify the folder number (numerals), the last five the folder name (letters). The first folder is assigned the name "100LEICA", the second "101LEICA". A folder will always be created with the next available number; you can have max. 999 folders.

### FILE STRUCTURE

The file names in these folders consist of eleven characters. In the factory settings, the first file is named "L1000001.XXX", the second "L1000002.XXX", etc. The first letter can be selected, the "L" from the factory settings denotes the camera brand. The first three characters signify the folder number (numerals). The next four digits denote the sequential file number. Once file number 9999 is reached, then a new folder will be automatically created, in which the file numbering begins at 0001 again. The last three places after the dot denote the file format (DNG or JPG).

#### Notes

- When using memory cards that were not formatted with this camera, the file numbering will begin with 0001 again. Should the memory card already contain a file with a higher number, then numbering will be continued from that number.
- A relevant message will be displayed on the LCD panel once folder number 999 and file number 9999 are reached, and all numbering must be reset.
- Format the memory card and reset the frame number right after to reset the folder number to 100.

## EDIT FILE NAMES

- Select **Storage Management** in the main menu
- Select **Edit File Name**
  - A keyboard submenu is displayed.
  - The input line contains the factory setting “L” as the first letter of the file name. Only this letter can be changed.
- Enter a letter of your choice (see p. 50)
- Confirm

### Notes

- The change to a file name applies to all subsequent files or until a new change is made. The sequential number will not be affected; but it will be reset when a new folder is created.
- During a reset to factory settings, the first letter will always be reset to “L”.
- Lower case letters are unavailable.

## ADDING COPYRIGHT INFORMATION

This camera allows you to enter letters and other characters as a copyright mark for your image files. You can enter up to 20 characters of information under 2 headings per shot.

- Select **Camera Information** in the main menu
- Select **Copyright Information**
- Activate the **Copyright** function (**On**)
- Select **Information/Artist** in the submenu
  - A keyboard submenu is displayed.
- Enter the desired information (see p. 50)
- Confirm

## LOGGING THE SHOOTING LOCATION (ONLY IN CONNECTION WITH THE LEICA FOTOS APP)

Location information can be sourced from a mobile device in connection with the Leica FOTOS app. Current location information will then be written to the Exif data of the images (geotagging).



- Activating GPS functions on a mobile device
- Activate Leica FOTOS and connect to the camera (see chapter “Leica FOTOS”)
- Activate geotagging for this camera in Leica FOTOS

### Notes

- The use of GPS and associated technologies may be restricted in some countries or regions. Violations will be prosecuted by local authorities. You should therefore contact your travel agent or the embassy of your destination country for relevant information beforehand.
- It will take a few seconds for the Bluetooth connection to establish. The configured shutdown time should be considered when choosing a delay time if shutdown is enabled in the camera.
- All images with location information are marked with the geotagging icon in review mode.

## GEOTAGGING STATUS

The status of existing location information is displayed on screen, provided the info bars are displayed and geotagging is enabled. The Control Center will always show the current geotagging status.

	The location information is current (most recent geolocation max. 15 mins prior).
	The location information is not necessarily current anymore (most recent geolocation max. 12 h prior).
	The available location information is outdated (most recent geolocation more than 12 h in the past). No location data will be written to Exif data.
No icon	Geotagging is deactivated.

Location information will be continuously updated as long as the camera is connected to Leica FOTOS. The Bluetooth function of the camera and the mobile device must therefore remain enabled to ensure latest information. It is, however, not necessary for the app to be running in the foreground.

## DATA TRANSFER

Data can be conveniently transferred to mobile devices via Leica FOTOS. Alternatively, a card reader or USB cable can be used for the transfer.

### VIA LEICA FOTOS APP

→ See chapter “Leica FOTOS” (p. 212)

### VIA USB CABLE

The camera supports multiple data transfer options. A transfer mode can be permanently selected or chosen every time a connection is established.

Factory setting: **Select on Connection**

→ Select **USB Settings** in the main menu

→ Select **USB Mode**

→ Select the desired setting

(**Mass Storage**, **PTP**, **Apple MFi**, **Select on Connection**)

- **Apple MFi** is used for the communication with iOS devices (iPhone and iPad)
- **PTP** allows a data transfer to computers using MacOS or Windows with PTP-capable programs, as well as tethering to Capture One Pro and Lightroom Classic
- The setting **Select on Connection** will automatically propose a connection method depending on the type of cable connection.

## Notes

- We recommend using a card reader for the transfer of large files.
- The USB connection must not be interrupted while data is being transferred, as the computer or the camera could otherwise “crash” and irreparable damage could occur on the memory card.
- The camera must not be turned off or automatically shut itself down due to a lack of battery power while data is being transferred, as this can cause the computer to crash. For the same reason, the battery must never be removed from the camera while the connection is active.

# PRACTICAL DEFAULT SETTINGS

## TOUCH AF

Touch AF allows a direct placement of the AF frame.

Factory setting: **Touch AF**

→ Select **Focusing** in the main menu

→ Select **Touch AF**



→ Select **Touch AF**

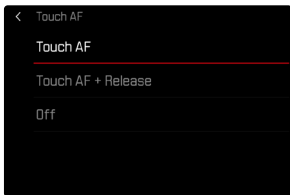

## Positioning the AF frame

→ Tap the LCD panel in the desired position

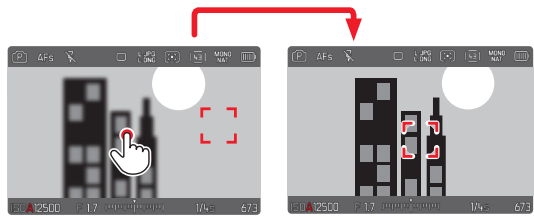

## Moving the focus frame back to the center of the screen

→ Double-tap the LCD panel

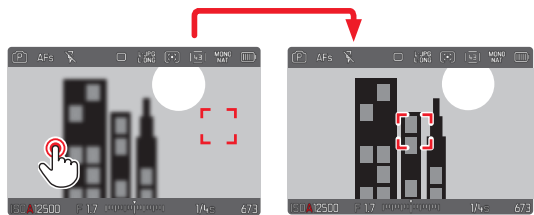

## Notes

- This function is available with all AF metering methods except **Multi-Field**.
- If the metering method **Tracking** is selected, the focus frame will remain at the selected position and auto-focus commences when the shutter button is tapped. For all other AF metering methods, focusing occurs automatically.
- The position of the AF frame can only be reset with a double-tap, even if the setting is **Off**.

## TOUCH AF + SHUTTER BUTTON

The combination **Touch AF + Release** allows a direct placement of the AF frame for immediate recording.

- Select **Focusing** in the main menu
- Select **Touch AF**
- Select **Touch AF + Release**
- Tap the LCD panel in the desired position

### Note

- The AF frame cannot be reset as usual via a double tap if **Touch AF + Release** is activated.

## TOUCH AF IN EVF MODE

Touch AF is deactivated by default when EVF is in use to prevent any inadvertent altering of the AF frame. AF Quick Setting (see p. 54) continues to be accessible. This function can also be disabled if that is not wanted (e.g. when focusing with the left eye).

Factory setting: **Off**

- Select **Focusing** in the main menu
- Select **Touch AF in EVF**
- Select the desired setting  
(**On**, **AF Quick Setting only**, **Off**)
- **On**
  - Positioning the AF frame (tap)
  - Accessing the AF Quick Setting (tap and hold)
- **AF Quick Setting only**
  - Accessing the AF Quick Setting (tap and hold)
- **Off**

## AUXILIARY DISPLAYS

You can select a number of other displays in addition to the standard information contained in the header and footer to adapt the screen image to your needs. The following functions are available:

- Grids (only shooting mode, see p. 78)
- Focus Peaking (see p. 79)
- Clipping (see p. 81)
- Level Gauge (only shooting mode, see p. 80)
- Histogram (see p. 80)

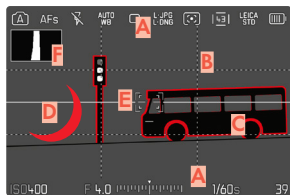

- A** Info Bars (= header and footer line)
- B** Grid lines
- C** Focus peaking
- D** Clipping
- E** Level gauge
- F** Histogram

- Select **Capture Assistants** in the main menu
- Select the desired function
- Select **On/Off**

## INFO PROFILES

Up to 4 independent profiles can be used in Photo mode. The desired function can be selected and adjusted individually for each profile. During operation, the switch between info profiles is done via direct access. In factory settings, that will be center button. It allows quick switches between various views.

Info Profiles will be configured and saved individually for Photo and Video mode.

Für Info Profiles in Video mode see p. 162.

The following profiles are predefined in the factory settings:

Profile	Factory Settings
1	Info bars only (Top / Bottom)
2	Full screen view (all auxiliary displays Off)
3	Info Bars (Top / Bottom + Right), Zebra, Focus Peaking, Histogram
4	Info Bars (Top / Bottom + Right), Grids, Zebra, Level Gauge

## CHANGING THE INFO PROFILES

- Press the function button with the **Toggle Info Levels** assignment
  - In factory settings, that will be center button.

### Note

- The same info profiles are available in review mode as in shooting mode. The actual info profile currently in use, however, is saved separately.

## Briefly showing/hiding information

- Tap and hold the shutter button
  - (Only) the exposure information and currently active auxiliary functions will be visible.

## DEACTIVATING INDIVIDUAL INFO PROFILES

You can limit the number of info profiles by activating/deactivating individual profiles. At least one profile must always be active, but that can be an “empty” profile.

- Select **Capture Assistants** in the main menu
- Select a profile
- Select **On**

## CUSTOMIZING THE INFO PROFILES

- Select **Capture Assistants** in the main menu
- Select a profile
- Select **Settings**
- Select the desired function
- Select the desired setting

Function	Available settings
Info Bars	Top / Bottom (On, Dark Background, Off) Right (On, Dark Background, Off)
Grids	3 x 3, 6 x 4, Off
Clipping	On, Off
Focus Peaking	On, Off Color (Red, Blue, Green, White) & Sensitivity (Low, Medium, High): Settings apply for all info profiles
Level Gauge	On, Off
Histogram	On, Off

### Note

- It is advisable to reserve one info profile as “empty”, in which all functions are set to **Off**. It allows you to temporarily hide all displays. In effect, you get an unobstructed view of the full screen image.

## SHOW AVAILABLE

### INFO BARS

The header and footer lines show the currently active settings and exposure values. See chapter “Displays” for a full list of the various displays (see p. 22).

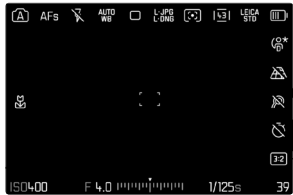

### QUICK START BAR

The Quick Start bar on the right offers access to all key functions in shooting mode:

- User Profile
- Perspective Control
- Focus Peaking
- Self-timer
- Aspect Ratio

## GRID LINES

The grids divide the image frame into multiple fields. They facilitate pictorial composition and an exact camera orientation.

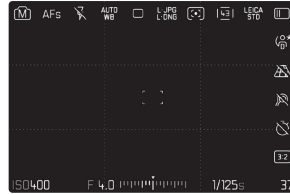

- Select **Capture Assistants** in the main menu
- Select **Grids**
- Select **On/Off**

## FOCUS PEAKING

This assist function highlights the edges of in focus subject elements in color. The color can be user-specified. The sensitivity can be additionally adjusted.

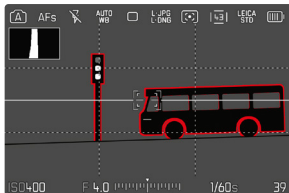

## HIGHLIGHT COLOR

Factory setting: **Red**

- Select **Capture Assistants** in the main menu
- Select the desired Info profile
- Select **Focus Peaking**
- Choose the desired color in the menu item **Settings**  
(**Off**, **Red**, **Green**, **Blue**, **White**)

## SENSITIVITY

Factory setting: **Medium**

- Select **Capture Assistants** in the main menu
- Select the desired Info profile
- Select **Focus Peaking**
- Choose the desired sensitivity in the menu item **Settings**  
(**Low**, **Medium**, **High**)

### Note

- Focus peaking is based on subject contrast, i.e. differences between light and dark. As a result, high contrast subject elements could be marked, even if they are not completely in focus.

## LEVEL GAUGE

The integrated sensors of the camera show its orientation. These indicators ensure exact camera orientation along the longitudinal and transverse axes of critical objects, e.g. architecture.

Deviations in relation to the longitudinal axis (i.e. when the camera is tilted up or down in the direction of view) are indicated by a short line in the center of the image

(1). Deviations in relation to the transverse axis (when the camera is tilted to the left or right) are indicated by two long lines to the left and right of the image center (2).



- Select **Capture Assistants** in the main menu
- Select **Level Gauge**
- Select **On/Off**

### Note

- The camera will switch the aspect of the level gauge autonomously for shoots in vertical format.

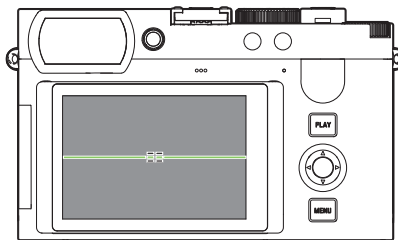

Correct alignment

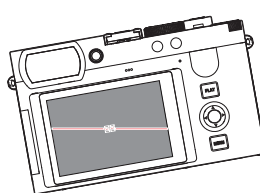

Tilted laterally to the left

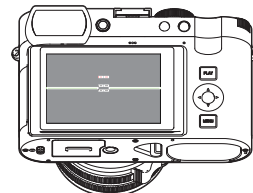

Tilted downward in the direction of view

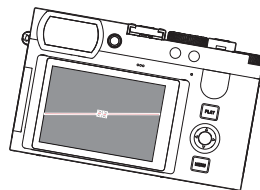

Tilted laterally to the right

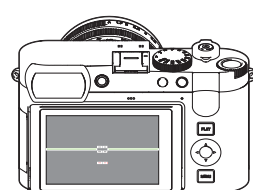

Tilted upward in the direction of view

## CLIPPING

The Clipping display marks very bright image areas. This function is a very easy and exact tool for checking the correct exposure setting. Overexposed areas flash black.

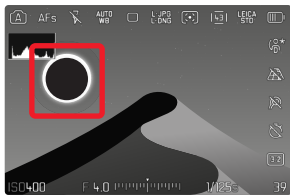

- Select **Capture Assistants** in the main menu
  - Select **Clipping**
  - Select **On/Off**
- 
- Tap and hold the shutter button
    - The clipping display appears.

## HISTOGRAM

Histogram represents the brightness distribution in the image. The horizontal axis shows the graduated values from black (left) through gray to white (right). The vertical axis corresponds to the number of pixels at each brightness level.

This type of rendering allows an additional quick and easy assessment of the exposure setting.

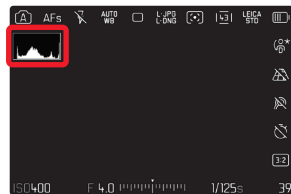

- Select **Capture Assistants** in the main menu
- Select **Histogram**
- Select **On/Off**

### Notes

- The histogram is always based on the brightness displayed; depending on the settings used, it may not represent the final exposure.
- In shooting mode, the histogram should be regarded as a “trend indicator”.
- The histogram during rendering may differ slightly from the one during exposure.
- The Histogram always refers to the currently displayed cropped section of the image.

## TEMPORARY ACTIVATION/DEACTIVATION OF INDIVIDUAL FUNCTIONS

The following assist functions can be activated/deactivated temporarily:

- Focus peaking
  - Clipping
- Assigning the desired assist function to a function button (see p. 54)
- Press the corresponding function button
- The status of the assist function toggles On/Off.
  - A relevant indicator appears in the screen image.

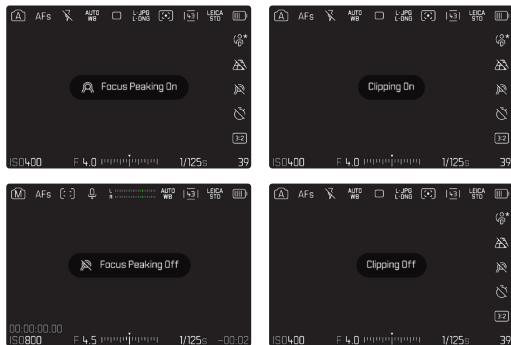

The temporary setting is reset when the camera is switched off.

## MF ASSIST FUNCTIONS

### AF ASSIST LAMP

The integrated AF assist lamp allows operation of the AF system in unfavorable lighting conditions. This lamp comes on while metering is performed, provided the function is activated.

Factory setting: **On**

- Select **Focusing** in the main menu
- Select **AF Assist Lamp**
- Select **On/Off**

### Notes

- The AF assist lamp illuminates an area of up to approx. 5 m.
- The AF assist lamp switches off automatically, once focusing was successful (AF frame is green) or has failed (AF frame is red).

## ACOUSTIC AF CONFIRMATION

You can set an acoustic confirmation signal for successful focus metering in AF mode.

Factory setting:  Off

- Select **Camera Settings** in the main menu
- Select **Acoustic Signal**
- Select **Volume**
- Select **Low/High**
- Select **AF Confirmation**
- Select  On
- Select **Notification Signals**
- Select  On

# PHOTOGRAPHY

The settings described in this chapter only apply for photo mode. They are therefore part of the photo menu and must always be accessed and configured from within photo mode (see chapter “Camera operation” in the section “Menu Control”). Any menu items of the same name in the video menu are entirely independent of these.

## DRIVE MODE

The functions and settings described in the following generally refer to the exposure of individual shots. In addition to single frame shooting, the Leica Q3 43 offers a number of other exposure modes. Please read the relevant sections for information about functionalities and setting options.

- Select **Drive Mode** in the main menu
- Select the desired function options

Mode	Setting options / Variants
Single frame shooting	<b>Single</b>
Continuous shooting (see p. 111)	Speed: <ul style="list-style-type: none"><li>– <b>2 fps, 14 bit, AF</b></li><li>– <b>4 fps, 14 bit, AF</b></li><li>– <b>5 fps, 12 bit, AF</b></li><li>– <b>7 fps, 14 bit</b></li><li>– <b>9 fps, 12 bit</b></li><li>– <b>15 fps, 12 bit</b></li></ul>
Interval shooting (see p. 112)	<b>Number of Frames</b> Interval between the shootings ( <b>Interval</b> ) Delay time ( <b>Countdown</b> )
Exposure bracketing (see p. 114)	<b>Number of Frames</b> (3 or 5) <b>EV Steps</b> <b>Exposure Compensation</b> <b>Automatic</b>

## FOCUSING

Your Leica Q3 43 allows automatic as well as manual focusing. There are 3 operating modes and 4 metering methods available for AF photography.

### AF PHOTOGRAPHY

- Press and hold the AF/MF release button
- Turn the focus ring to the **AF** position
- Position the AF frame as needed
- Tap and hold the shutter button
  - Focusing occurs one time (AFs) or continuously (AFc).
  - Metering was successful: The AF frame lights up green.
  - Metering was unsuccessful: The AF frame lights up red.
  - Alternatively, focus and/or exposure settings can be configured and saved via one of the function buttons ("Exposure lock", see p. 108).
- Shutter release

### MF PHOTOGRAPHY

- Press and hold the AF/MF release button
- Turn the focus ring away from the **AF** position
- Use the focus ring to manually focus on the object
- Shutter release

Please read the following chapters for more information.

## AUTOFOCUS MODES

The following AF modes are available: **AFs**, **AFc** and **Intelligent AF**. The currently selected AF mode is shown in the header line.

Factory setting: **AFs**

- Select **Focusing** in the main menu
- Select **Focus Mode**
- Select the desired setting (**Intelligent AF**, **AFs**, **AFc**)

### INTELLIGENT AF (iAF)

In this mode, the camera will refocus as soon as it registers a color or brightness/contrast change in the entire image section. The focus field depends on the autofocus metering method selected.

#### AFs (single)

Suitable for objects with little or no movement. Focusing is done only once and the setting remains as long as the shutter button is held at the pressure point. That also applies if the AF frame is pointed at another object.

#### AFc (continuous)

Suitable for objects in motion. As long as the shutter button is held at the 1st pressure point, focusing is continuously adjusted to the object in the AF frame.

## AF FOCUSING METERING METHODS

The AF mode offers various metering methods for focusing. A successful focus setting is identified by a green frame, an unsuccessful one is shown in red.

Factory setting: **Field / Spot**



- Select **Focusing** in the main menu
- Select **AF Mode**
- Select the desired setting  
(**Field / Spot**, **Zone / Multi-Field**, **Tracking**)

### Notes

- AF focusing can be unsuccessful:
  - if the distance to the object is too great (macro mode) or too small
  - if the object is not sufficiently illuminated
- Touch AF allows a direct placement of the AF frame. See p. 74 for more information.
- The size of the focus frame can be set for Field/Spot Metering and for Zone/Multi-Field Metering. See p. 89 for more information.

## FIELD/SPOT METERING

In this mode, only the subject elements within the AF frame will be captured. The focus area is marked by a small frame. The measuring range permits selective metering.

This mode can also be used for serial exposures in which the sharply focused object element will always be at the same off-center position in the image.

Simply move the AF frame to another position (see p. 91).

## ZONE/MULTI-FIELD METERING

In this mode, sections of the object are captured automatically using a continuous group of multiple focus fields. This function combines some security for snapshots with the option of aiming at larger objects reliably.

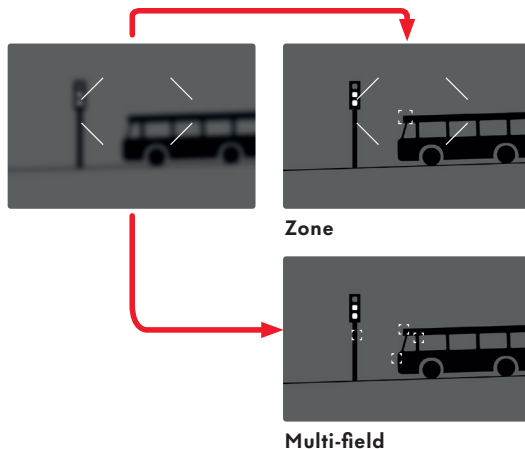

Once the setting has been made, the focus frames are displayed where object sections are displayed in focus.

## TRACKING

This mode is useful for the capture of moving objects. The focus on the object in the focus frame is continuously adjusted, once it is detected.

- Aim the focus frame at the desired object (by panning the camera shifting the focus frame)
- Tap and hold the shutter button

or

- Press the function button (provided it was assigned the function **AF-L** or **AF-L + AE-L**, see p. 108)
  - The camera focuses on the object.
- Pan the camera to the desired cropped section
  - The focus frame “tracks” the saved object and focus is continuously adjusted.

### Note

- This metering method focuses continuously, even if the AF mode **AFs** was set.
- The size of the focus area may change when tracking an object.
- The type of the tracked object depends on the setting under the menu item **AF Detection**. When **AF Detection** is set to people or animals, the system will search for, recognize, and track only people or animals.
- **AF Detection** must be set to **Off** if objects should be tracked instead.

## AF DETECTION (AUTOMATIC SUBJECT RECOGNITION)

The camera automatically detects various subjects – including people and animals – and focuses specifically on eyes, faces, or bodies. The main subject remains reliably in focus, even if there is movement or a brief obstruction. Automatic subject recognition provides precise and continuous focus tracking in every shooting situation.

Setting: **Human (Eye/Face/Body)**

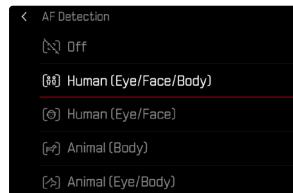

- Select **Focusing** in the main menu
- Select **AF Detection**
- Select the desired setting (**Off**, **Human (Eye/Face/Body)**, **Human (Eye/Face)**, **Animal (Body)**, **Animal (Eye/Body)**)

### Note

- Where rapid changes to AF detection are necessary, **AF Detection** can be assigned to a function button (see p. 54).

## EYE/FACE/BODY DETECTION

Setting: **Human (Eye/Face/Body)**

In addition to biometric face patterns, the camera also detects body patterns and uses these for focusing during Eye/Face/Body Detection. Tracking will therefore continue, once a person is detected and measured, even if the face may not be in view at some point. This feature prevents inadvertent “jumps” to other faces if several persons are in the frame.

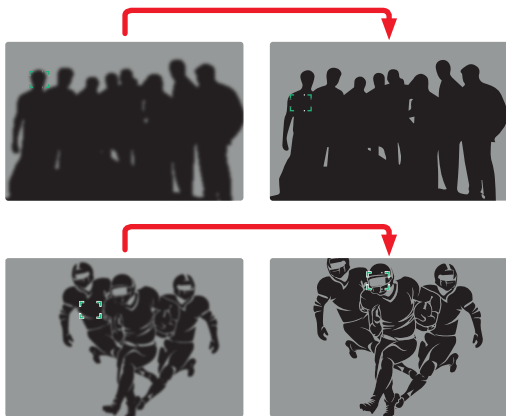

## FACE DETECTION

Setting: **Human (Eye/Face)**

In face detection, biometric face patterns are detected and used for automatic focusing. An appropriate face is tracked continuously. When face detection detects an eye, the focus will be on that eye. Should more than one eye be detected, then the user can choose the eye to focus on. The currently selected eye will be highlighted.

Additionally, the desired face can be easily selected if there are several faces in the frame.

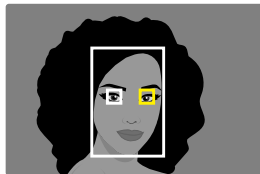

### toggling between faces and/or eyes

→ Press the directional pad in the relevant direction

## ANIMAL DETECTION

Settings: **Animal (Body)** or **Animal (Eye/Body)**

In Animal Detection mode, several common pet species are recognized and brought into focus.

## AF DETECTION IN COMBINATION WITH ZONE/MULTI-FIELD METERING

With Zone / Multi-Field metering, the desired focus point can be selected from all subjects detected within the measurement area.

- Press the directional pad in the relevant direction
  - A white outline indicates recognized objects, while a yellow outline highlights the selected object.



## AF QUICK SETTING

The AF Quick Setting allows quick changes to the focus frame size in some AF metering methods.

The screen image will remain visible continuously while settings are being adjusted.

### ACCESSING AF QUICK SETTING

- Tap and hold the LCD panel
  - All auxiliary displays are hidden.
  - White triangles appear at two corners of the focus frame when the metering method **Field / Spot** or **Zone / Multi-Field** is set as the AF Mode.

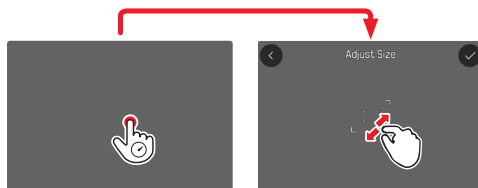

### ADJUSTING THE AF FRAME SIZE

(only **Field / Spot** or **Zone / Multi-Field**)

- Turn the thumbwheel
- or
- Two-finger pinch/spread
  - The size of the AF frame is adjustable in 3 increments.
- or
- Press the function button
  - The **AF Frame Size** function must be assigned to one of the function buttons to use this feature (see p. 54).

## MF ASSIST FUNCTIONS

### ENLARGEMENT IN AF MODE

You can access the enlargement function independent of focusing for a better assessment of the settings.

The **Magnification** function must be assigned to one of the function buttons to use this feature.

#### Assigning a function to a function button

→ See p. 54

#### Accessing the enlargement function

→ Press the function button

- An enlarged image section appears. The position of the enlargement depends on the position of the AF frame.
- The rectangle within the frame at the top right represents the current magnification, as well as its position in the displayed cropped section.



#### Adjusting the enlargement function

→ Turn the thumbwheel

- The image section toggles between magnification factors.

#### Changing the position of the enlarged section

→ Press the directional pad in the relevant direction

#### Exiting the enlargement function

→ Tap the shutter button

or

→ Press the function button again

#### Notes

- The enlargement function remains active until it is exited.
- The most recently magnification function will still be active the next time the feature is accessed.

### AF ASSIST LAMP

The integrated AF assist lamp allows operation of the AF system in unfavorable lighting conditions. This lamp comes on while metering is performed, provided the function is activated.

See p. 63 for settings.

### ACOUSTIC AF CONFIRMATION

You can set an acoustic confirmation signal for successful focus metering in AF mode (see p. 63).

## SHIFTING THE AF FRAME

All AF metering methods permit shifting the AF frame before focusing.

- Press the directional pad in the relevant direction or
- Tap the LCD panel in the desired position (While Touch AF is activated)

### Notes

- The focus frame will remain at the most recently used position for this AF metering method even if the user changes the AF metering method or the camera is switched off.
- Focus areas will be interlinked if the exposure metering method **Spot** is combined with the AF metering methods (**AF Mode**) **Field / Spot** or **Zone / Multi-Field**. Exposure metering will then occur at the point specified by the AF frame, even if it is moved.
- The focus area can be centered. The function **Toggle Focus Point** must be assigned to one of the function buttons (see p. 54).

## MANUAL FOCUSING (MF)

Focusing manually may in some situations be a better choice than autofocus.

- the same setting is used for several shoots
  - it would take longer to use the metering memory lock function
  - the setting is to be kept at infinity for landscape pictures
  - poor, i.e. very dark lighting conditions prevent AF operation or would slow it down
- Move the focus ring out of the **AF** position (press and hold the AF/MF lock release)

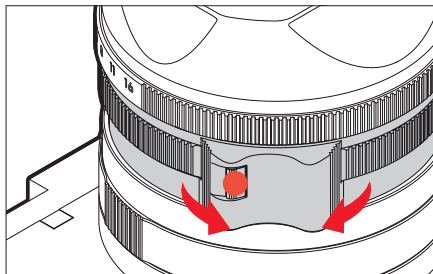

- Turn the focus ring until the desired part of the object is in clear focus

## MF ASSIST FUNCTIONS

The following assist functions are available in MF mode.

### FOCUS PEAKING

This assist function highlights the edges of in focus subject elements in color. The color can be user-specified. The sensitivity can be additionally adjusted. See p. 79 for settings.

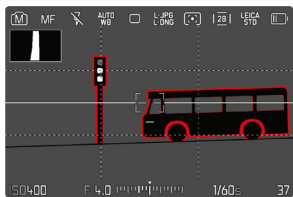

- Select **Capture Assistants** in the main menu
- Select **Settings**
- Select **Focus Peaking**
- Select the desired setting  
(Off, Red, Green, Blue, White)
- Specify an image section
- Turn the focus ring to mark the desired subject elements

### Note

- Focus peaking is based on subject contrast, i.e. differences between light and dark. As a result, high contrast subject elements could be marked, even if they are not completely in focus.

## ENLARGEMENT IN MF MODE

The larger the details of the object are shown, the better you can assess their sharpness and the more accurately you can focus.

This function can be automatically activated during manual focusing or can be accessed independently.

### ACCESS VIA THE FOCUS RING

Turning the focus ring will automatically enlarge a image section.

- Select **Focusing** in the main menu
- Select **Auto Magnification**
- Select **On**
- Turn the focus ring
  - An enlarged image section appears. The position of the enlargement depends on the position of the AF frame.
  - The rectangle within the frame at the top right represents the current magnification, as well as its position in the displayed cropped section.

## Adjusting the enlargement function

- Turn the thumbwheel
  - The image section toggles between magnification factors.

## Changing the position of the enlarged section

- Press the directional pad in the relevant direction

## Exiting the enlargement function

- Tap the shutter button

### Notes

- The enlargement will automatically return to normal viewing size about 5 s after the last movement of the focus ring.
- The most recently magnification function will still be active the next time the feature is accessed.

## ACCESS VIA THE FUNCTION BUTTON

You can access the enlargement function independent of focusing for a better assessment of the settings. The **Magnification** function must be assigned to one of the function buttons to use this feature (see p. 54).

## Assigning a function to a function button

- See p. 54

## Accessing the enlargement function

- Press the function button
  - An enlarged image section appears. The position of the enlargement depends on the position of the AF frame.
  - The rectangle within the frame at the top right represents the current magnification, as well as its position in the displayed cropped section.

## Adjusting the enlargement function

- Press the center button
  - The image section toggles between magnification factors.

## Changing the position of the enlarged section

- Move the position of an enlarged cropped section by swiping

or

- Press the directional pad in the relevant direction

## Exiting the enlargement function

- Tap the shutter button

### Note

- The enlargement function remains active until it is exited.

## MACRO FUNCTION

The working range for the focus setting can be switched quickly and easily from the standard focus range (30 cm to infinity) to the macro range (17 cm to 30 cm) using the macro ring. AF and MF mode are available in both ranges.

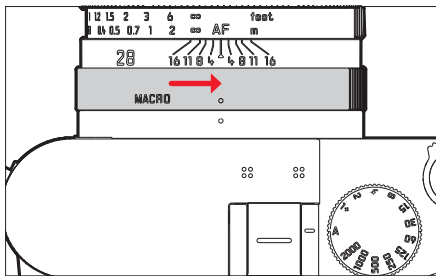

→ Turn the macro ring until the alignment point is set to **MACRO**

- The distance scales on the focus ring change when the focus ranges change.

### Notes

- When using the compact lens hood, it is not possible to use a filter in connection with the macro function.
- We offer an aluminum lens hood (Order No. 19658) as an optional accessory for this purpose: <https://store.leica-camera.com>

## ISO SENSITIVITY

The ISO setting covers a range between ISO 50 and ISO 100 000, allowing you to adapt to the relevant situation as required.

There is more leeway for the use of preferred shutter-speed/aperture combinations when choosing an automatic ISO setting. You can set priorities within the scope of the automatic setting, e.g. for reasons of pictorial composition.

Factory setting: **Auto ISO**

### FIXED ISO VALUES

Values between ISO 50 and ISO 100 000 can be selected in 14 increments. Manual ISO settings are initially done in full EV steps, and from ISO 50,000 in 1/3 EV steps.

- Select **ISO Settings** in the main menu
- Select **ISO**
- Select the desired value

### Note

- When high ISO values are used or the image is edited later, image noise, as well as vertical and horizontal stripes may become visible, particularly in larger, evenly lit areas of the object.

## AUTOMATIC SETTING

The camera automatically adjusts the sensitivity to ambient brightness and/or to the configured shutter-speed/aperture combination. In conjunction with aperture-priority mode, this function extends the range for automatic exposure control. The automatic setting of ISO sensitivity occurs in increments of 1/3 EV.

- Select **ISO Settings** in the main menu
- Select **ISO**
- Select **Auto ISO**

## LIMITING SETTING RANGES

A max. ISO value can be set, which will then limit the automatic setting (**Maximum ISO**). A max. exposure time can also optionally be configured. There are automatic settings and fixed max. shutter speeds **1/2**s and **1/2000**s available for that purpose.

Separate settings are available for flash photography.

## LIMITING ISO VALUES

All values from ISO 200 are available.

Factory setting: **6400**

- Select **ISO Settings** in the main menu
- Select **Auto ISO Settings**
- Select **Maximum ISO**
- Select the desired value

## LIMITING SHUTTER SPEED RANGES

Factory setting: **Auto**

- Select **ISO Settings** in the main menu
- Select **Auto ISO Settings**
- Select **Shutter Speed Limit**
- Select the desired value  
(**Auto**, **1/2000**, **1/1000**, **1/500**, **1/250**, **1/125**, **1/60**, **1/30**, **1/15**, **1/8**, **1/4**, **1/2**)

## LIMITING ISO VALUES (FLASH)

All values from ISO 200 are available.

Factory setting: **6400**

- Select **ISO Settings** in the main menu
- Select **Auto ISO Settings**
- Select **Maximum ISO (Flash)**
- Select the desired value

## LIMITING SHUTTER SPEED RANGES (FLASH)

Factory setting: **Auto**

- Select **ISO Settings** in the main menu
- Select **Auto ISO Settings**
- Select **Shutter Speed Limit (Flash)**
- Select the desired value  
(**Auto**, **1/200**, **1/125**, **1/60**, **1/30**, **1/15**, **1/8**, **1/4**, **1/2**)

## DYNAMIC ISO SETTING

The thumbwheel can be configured to allow manual ISO settings in real time (see p. 54). The settings will cycle through all values available in the **ISO** menu. That means that **Auto ISO** can also be selected.

## WHITE BALANCE

In digital photography, White Balance ensures neutral color rendering in any light. White Balance relies on the setting made in the camera, which light color is to be rendered as 'white'.

Four methods are available:

- automatic control
- fixed presets
- manual setting via metering
- direct setting of the color temperature

Factory setting: **Auto**

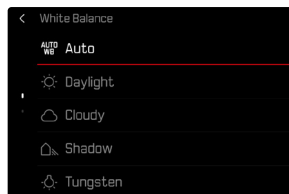

## AUTOMATIC CONTROL/FIXED SETTINGS

- **Auto**: for automatic control, which delivers neutral results in most situations
- Various fixed presets for most frequently encountered light sources:

Daylight	For outdoor shootings in sunlight
Cloudy	For outdoor shootings in cloudy conditions
Shadow	For outdoor shootings with the main subject in shadow
Tungsten	For indoor shootings with (predominantly) incandescent lamp light
Flash	For flash photography

- Select **White Balance** in the main menu
- Select the desired setting

## MANUAL SETTING VIA METERING

This metering variant captures all color hues in the metering field and uses these to calculate a mean gray value.

- Select **White Balance** in the main menu
- Select **Gray Card**
  - The following appears on the LCD panel:
    - the image based on automatic white balance
    - a frame in the center of the image

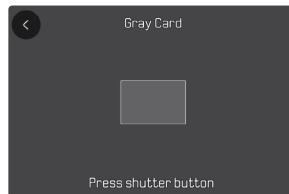

- Aim the metering field at a white or neutral gray area
  - The screen image changes dynamically in line with the reference area in the frame.

### Performing measurement

- Shutter release
  - The measurement is taken.

### Cancelling measurements

- Press the center button

### Note

- A value configured using this method will remain unchanged (i.e. it will be used for all subsequent photographs) until new measurements are taken or one of the other white balance settings is selected.

## DIRECT SETTING OF THE COLOR TEMPERATURE

Values between 2000 and 11500 K (Kelvin) can be set directly. That gives you a very wide range, which covers virtually all color temperatures occurring in real life and within which you can adapt color rendering to any light color and your personal preferences with incredible detail.

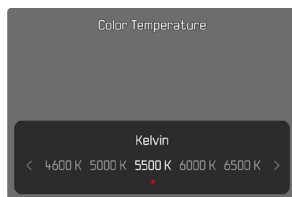

- Select **White Balance** in the main menu
- Select **Color Temperature**
- Select the desired value

## EXPOSURE

### SHUTTER TYPE

The Leica Q3 43 comes equipped with a mechanical shutter and a purely electronic shutter function. The electronic shutter expands the available shutter area and functions completely noiseless, which may be important in some work environments.

Factory setting: **Hybrid**

- Select **Shutter Type** in the main menu
- Select the desired setting

<b>Mechanical</b>	Only the mechanical shutter is used. Working range: 60 min to 1/2000 s.
<b>Electronic</b>	Only the electronic shutter function is used. Working range: 60 s to 1/16000 s.
<b>Hybrid</b>	You can add the electronic shutter function if you need faster shutter speeds than can be achieved with the mechanical shutter. Working range: 60 min to 1/2000 s + 1/2500 s to 1/16000 s.

## USE

The classic shutter sound of the mechanical shutter conveys an auditive feedback. It is well suited for long-term exposures, as well as for shots of moving objects.

The electronic shutter function allows photography with an open aperture in very bright due to very fast shutter speeds. The distinctive “rolling shutter” effect makes it less suitable for moving objects.

## Notes

- The electronic shutter function does not allow flash photography.
- The electronic shutter function in combination with fast shutter speeds can result in stripe effects on the images when used with LED or fluorescent tube lighting.

## EXPOSURE METERING METHODS

Factory setting: **Multi-Field**

- Select **Exposure Metering** in the main menu
- Select the desired metering method (**Spot**, **Center-Weighted**, **Highlight-Weighted**, **Multi-Field**)
  - The selected metering method is displayed in the header line of the screen image.

Spot metering allows a shifting of the focus point.

- Press the directional pad in the relevant direction

## Note

- The exposure information (ISO value, aperture, shutter speed and light balance with exposure compensation scale) will help to determine the settings required for correct exposure.

## SPOT

This metering method is concentrated exclusively on a small area in the center of the image. The metering fields are joined together when the exposure metering method **Spot** is combined with the AF metering methods **Spot** and **Field**. Exposure metering will then occur at the point specified by the AF frame, even if it is moved.

## CENTER-WEIGHTED

This method considers the entire image field. The subject elements captured in the center will, however, impact on the calculation of the exposure value more so than areas around the edges.

## MULTI-FIELD

This metering method is based on the detection of multiple values. These values are used in an algorithm to calculate an exposure value appropriate for a good rendering of the assumed main subject.

## HIGHLIGHT-WEIGHTED

This method considers the entire image field. The exposure value will, however, be adjusted to very bright subject elements. That prevents the overexposure of bright subject elements without having to measure them individually. This metering method is particularly useful for objects that are significantly more brightly lit than the rest of the image (e.g. people in a spotlight), or that reflect the light significantly (e.g. white clothing).



## EXPOSURE MODES

There are four exposure modes available to adjust the rendering of the object or to create the desired pictorial composition:

- Program AE mode (**P**)
- Aperture-priority mode (**A**)
- Shutter-priority mode (**S**)
- Manual setting (**M**)

These four “classic” modes are accessed via a relevant setting of the shutter-speed dial and the aperture ring. A correct setting for the menu item **Scene Mode** (see p. 101) is prerequisite for the use of **P**, **A**, **S** and **M**. The menu item **P-A-S-M** **must** be selected. Should one of the 10 object and situational automatic program variants be selected instead, then that setting will take precedence over the settings of the physical control elements. The shutter-speed dial and the aperture ring will in that case have no assigned function.

## SELECTING A MODE

The four operating modes are activated automatically via the following setting combinations:

	Setting via the shutter-speed dial	Setting via the aperture ring
<b>P</b>	<b>A</b>	<b>A</b>
<b>A</b>	<b>A</b>	manual setting (not <b>A</b> )
<b>S</b>	manual setting (not <b>A</b> )	<b>A</b>
<b>M</b>	manual setting (not <b>A</b> )	manual setting (not <b>A</b> )

- Select **Scene Mode** in the main menu
- Select **P-A-S-M**
- Set the shutter-speed dial to the relevant position
- Set the aperture ring to the relevant position

## FULLY AUTOMATIC EXPOSURE SETTING – P

### PROGRAM AE MODE – P

The program AE mode facilitates fast and fully automatic photography. The exposure is controlled by an automatic shutter speed and aperture setting.

- Select **Scene Mode** in the main menu
  - Select **P-A-S-M**
  - Turn the shutter-speed dial to the **A** position
  - Turn the aperture ring to the **A** position
  - Tap and hold the shutter button
    - Exposure information is displayed at the bottom of the screen. This contains the automatically set value pair of aperture setting and shutter speed.
    - All other visible displays of the info bars will be hidden.
  - Shutter release
- or
- Adjusting the automatically set value pair (Program shift)

## CHANGING THE PRESET SHUTTER SPEED AND APERTURE COMBINATIONS (SHIFT)

Changing the preset values using the Shift function combines the reliability and speed of fully automatic exposure control with the opportunity to vary the speed/aperture combination selected by the camera at any time to fit in with your own ideas and intentions. The overall exposure, i.e. the brightness of the image, remains unchanged. Faster shutter speeds are a good choice for e.g. sports pictures, while longer speeds will offer more depth of field for e.g. landscape pictures.

- Turn the thumbwheel to the left/right  
(right = greater depth of field with slower shutter speeds, left = faster shutter speeds with lesser depth of field)
- Shifted value pairs are marked with an asterisk next to the **P**.

### Note

- The adjustment range is limited to guarantee correct exposure.

## SEMI-AUTOMATIC EXPOSURE SETTING – A/S

### APERTURE-PRIORITY MODE- A

Aperture-priority mode sets the exposure automatically according to the manually selected aperture. This mode is suitable for shots in which the depth of field is a critical compositional element.

A correspondingly small aperture value will allow you to shrink the depth of field range. This can be helpful when e.g. offsetting the highly focused face in a portrait against an unimportant or distracting background. Conversely, you can use a higher aperture value to increase the depth of field range, so that everything from the foreground to the background will be in full focus in a landscape shot.

- Select **Scene Mode** in the main menu
- Select **P-A-S-M**
- Turn the shutter-speed dial to the **A** position
- Set the desired aperture value
- Tap and hold the shutter button
  - Exposure information is displayed at the bottom of the screen. This contains the automatically set value pair of aperture setting and shutter speed.
  - All other visible displays of the info bars will be hidden.
- Shutter release

## SHUTTER-PRIORITY MODE – S

Shutter-priority mode will set exposure automatically according to the manually selected shutter speed. It is therefore particularly suitable for pictures of moving objects, where the sharpness of the movement depicted is a critical picture composition element.

An appropriately fast shutter speed can help to avoid e.g. unwanted motion blurring and will “freeze” the object. Conversely, an appropriately longer shutter speed can help create a better feeling of motion in the image with targeted “tracer effects”.

- Select **Scene Mode** in the main menu
- Select **P-A-S-M**
- Turn the aperture ring to the **A** position
- Set the desired shutter speed
  - using the shutter-speed dial: in full increments
  - using the thumbwheel: fine tuning in 1/3 increments
- Tap and hold the shutter button
  - Exposure information is displayed at the bottom of the screen. This contains the automatically set value pair of aperture setting and shutter speed.
  - All other visible displays of the info bars will be hidden.
- Shutter release

### Note



- Alternatively, fine tuning can be done via the Control Center. Depending on the thumbwheel assignment, this may be the only option (see p. 54).

## MANUAL EXPOSURE SETTING – M

The following manual settings for shutter speed and aperture are a good choice:

- to create a special image mood that can only be achieved with a very specific type of exposure
- to ensure a perfectly identical exposure for multiple images with different cropped sections
- Select **Scene Mode** in the main menu
- Select **P-A-S-M**
- Set the desired exposure manually (using the shutter-speed dial and the aperture ring of the lens)
  - The exposure compensation is done using the scale of the light balance.
- Tap and hold the shutter button
  - Exposure information is displayed at the bottom of the screen.
  - All other visible displays of the info bars will be hidden.
- Shutter release

Displays on the light balance:

	Correct exposure
	Underexposure or overexposure by the displayed value
	Underexposure or overexposure by more than 3 EV (Exposure Value)

## Notes

- The screen image will show an exposure preview if **P-A-S-M** is selected in the menu item **Exposure Preview** (after exposure metering, see p.107).
- The shutter-speed dial must be clicked to one of the engraved exposure shutter speeds.

## SETTING SHUTTER SPEEDS

The shutter speed is set in two steps.

1. using the shutter-speed dial: in full increments
2. using the thumbwheel: fine tuning in 1/3 increments

Shutter-speed dial	Thumbwheel
All settings from <b>2</b> to <b>1000</b>	Fine tuning the shutter speed in 1/3 EV increments, max. $\pm 2/3$ EV
Set to <b>1+</b>	Longer shutter speeds than 1 s (0.6 s to 60 min in 1/3 EV increments)
Set to <b>2000</b>	Shorter shutter speeds than 1/2000 s (1/1250 s to 1/16000 s in 1/3 EV increments)

## EXAMPLES FOR SHUTTER SPEED FINE TUNING SETTINGS

- set shutter speed 1/125 s + move the thumbwheel one click to the right = 1/100 s
- set shutter speed 1/500 s + move the thumbwheel two clicks to the left = 1/800 s

### Note

- Alternatively, fine tuning can be done via the Control Center. This may be the only option depending on the thumbwheel assignment.

## LONG-TERM EXPOSURE

### FIXED SHUTTER SPEEDS

Your Leica Q3 43 allows shutter speeds up to 60 minutes in modes **S** and **M** (depending on the selected ISO setting). The remaining exposure time after shutter release is counted down in seconds on the display for shutter speeds greater than 1 s.

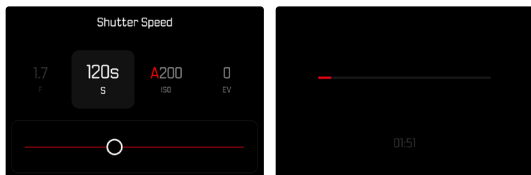

- Set the shutter-speed dial to **1+**
- Select the desired shutter speed (Must be done via fine tuning of the shutter speed, see p. 104)
- Shutter release
  - The current exposure time is displayed on the LCD panel with a significantly dimmed brightness.

## T FUNCTION

In this setting, the shutter remains open after shutter release until the shutter button is pressed again (ax. 2 min depending on ISO setting).

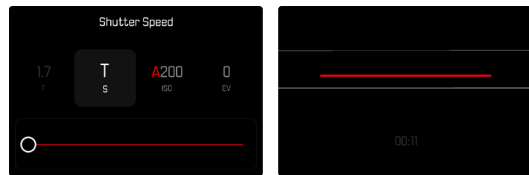

- Set the shutter-speed dial to **1+**
- Set the aperture ring to a fixed value
- Select **T** as the shutter speed (Must be done via fine tuning of the shutter speed, see p. 104)
- Shutter release
  - The current exposure time is displayed on the LCD panel with a significantly dimmed brightness.

### Notes

- The maximum selectable shutter speed depends, among other things, on the setting of the menu item **Shutter Type**, see p. 98. The T function is available only if **Shutter Type** is set to **Mechanical** or **Hybrid**.
- The remaining exposure time after shutter release is counted down in seconds on the display for shutter speeds greater than 1 s.

## NOISE REDUCTION

Image noise becomes more apparent when using higher sensitivities, particularly on uniform dark areas. Long exposure times may cause severe image noise. In order to reduce this annoying phenomenon, the camera will take a second “dark frame” (taken with the shutter closed) automatically after a shooting with slow shutter speed and high ISO value. The noise metered in this parallel shot will then be “subtracted” digitally from the data for the actual shot. In such cases the message **Noise reduction in progress...** will appear with a relevant time value.

This “exposure time” doubling must be taken into account in long-term exposures. The camera must not be switched off during that time. We recommend disabling Noise Reduction to allow shooting multiple frames in series and to apply noise reduction later during the post-editing stage. The images will have to be taken in raw data format.

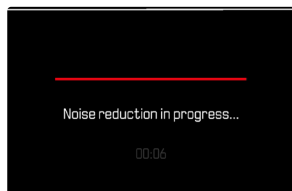

Under certain conditions, noise reduction will always be active as long as the function is enabled. That includes shots taken with the T function, as well as long-term exposure frames with shutter speeds of  $\geq +8$  s.

In all other cases, noise reduction depends on a combination of factors (specifically ISO setting, exposure time, and sensor temperature). The following table contains a list of shutter speeds typical for a sensor temperature of 25°C, at which noise reduction would be applied.

ISO	Shutter speed longer than
100	7 s
200	6.4 s
400	5.9 s
800	5.4 s
1600	4.9 s
3200	4.5 s
6400	4.2 s
$\geq 12\,500$	3.8 s

Noise Reduction can be optionally deactivated (see p. 67).

## EXPOSURE CONTROL

### EXPOSURE PREVIEW

The brightness of the screen image mirrors the effects of the selected exposure settings when pressing and holding the shutter button on the first pressure point. That allows an assessment the effect of the relevant exposure setting on the image before taking the photo. This will apply as long as the subject brightness and the set exposure don't result in excessively low or high brightness values.

This function can be disabled for the manual exposure setting (**M**).

Factory setting: **P-A-S-M**

- Select **Exposure Preview** in the main menu
- Select **P-A-S** (only in program AE, aperture-priority AE and shutter-priority AE mode) or **P-A-S-M** (also for manual setting)

### Notes

- Depending on ambient lighting conditions, the brightness of the screen image may differ from that of the actual images, despite the settings described above. The screen image will appear considerably darker than the – correctly exposed – picture. That is particularly the case in long-term exposures.
- The exposure preview will also be displayed if exposure metering is done via another control element (e.g. using the function button, provided it was assigned the **AE-L** function).
- The exposure preview will differ in **M** mode depending on the selected ISO setting:
  - With **Auto ISO** selected, the preview will only appear once the shutter button is pressed to the first pressure point.
  - Where an ISO value is fixed, the preview will also be displayed in Live View.

## EXPOSURE LOCK

We often want to arrange important subject elements outside the center of the image for reasons of pictorial composition and these elements may sometimes be very bright or very dark. Center-weighted metering and spot metering, however, mainly capture an area in the center of the image and are calibrated to an average gray scale value.

In that case, the exposure lock initially allows a metering of the main subject, as well as storing of the relevant settings until the final image section is set. The same applies for focusing (AF-L) in any autofocus mode.

Usually both lock functions (focusing and exposure) are done at the same time with the shutter button. Additionally, you can divide the memory functions between the shutter button and the function button, or assign both to a function button.

The functions include settings and storage.

## AE-L (AUTO EXPOSURE LOCK)

The camera stores the exposure value. The focus can therefore be set on another object, no matter which exposure value is selected.

## AF-L (AUTO FOCUS LOCK)

The camera stores the focus setting. That makes it easier to change the image section when focusing is fixed.

## AE-L/AF-L

With this option enabled, the camera stores the exposure value and the focus setting when the assigned button is pressed and held.

## Notes

- An exposure lock doesn't make much sense in conjunction with multi-field metering, because a targeted capture of an individual object element will not be possible.
- Any previously set exposure lock will be removed by a manual setting of the aperture ring or the shutter-speed dial.

## EXPOSURE LOCK IN AF MODE

The metering functions are distributed as follows while the function button is pressed and held:

Function button assignment	Function button	Shutter button
AF-L + AE-L	Exposure and focus	No function
AF-L	Sharpness	Exposure
AE-L	Exposure	Sharpness

The shutter button will retain both functions, provided no exposure lock is done via the function button.

### Via the shutter button

- Aim at the key part of the object or at a similar detail
- Tap and hold the shutter button
  - The measurement is taken and saved.
- Pan the camera to capture the final image section while keeping the shutter button pressed
- Shutter release

### Via a function button

- Assign the desired memory lock (AF-L + AE-L, AE-L, AF-L) to one of the function buttons (see p. 54)
- Aim at the object
- Press the function button
  - The measurement is taken and saved.
  - A small padlock icon with the letters AE appear at the bottom left of the screen to signify that the exposure value was saved.
  - A green AF frame signifies that the focusing was saved.
- Store more measurements via the shutter button as needed
- Specify the final image section
- Shutter release

## EXPOSURE LOCK IN MF MODE

In MF mode, only the exposure can be locked via the shutter button. Similarly, the function button will only have that one function (with an assignment of AF-L + AE-L or AE-L).

## EXPOSURE COMPENSATION

Exposure meters are calibrated for a medium gray scale value, which matches a standard, i.e. average image object. Should the measured image detail not fulfill that requirement, then the a relevant exposure compensation can be effected.

Specifically where several shots are taken in sequence, for example if for a series a slightly lesser or greater exposure is desired for a particular reason, then exposure compensation can be a very useful function: Unlike with exposure lock, the setting remains active until it is reset. Exposure compensation values can be set in the range  $\pm 3$  EV in  $1/3$  EV increments (EV: Exposure Value).

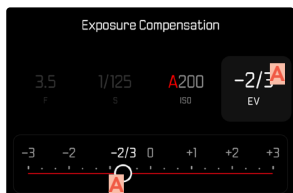

Control Center

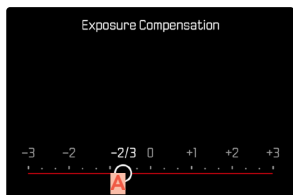

Camera menu

**A** Set compensation value (marks at 0 = Off)

### Using thumbwheel control

- Select **Customize Control** in the main menu
- Select **Thumbwheel**
- Select **Manual**
- Select **Exposure Compensation**
- Set the desired value using the thumbwheel

### Using menu control

- Select **Exposure Compensation** in the main menu
  - A scale appears as a submenu item on the LCD panel.
- Set the value on the scale
  - The set value is displayed above the scale.
  - While setting the value, you can see the effect on the screen image, which becomes darker or lighter.

### **Note**

- The following applies for set compensation values, no matter how they were initially set: They remain effective until they are manually reset to **0**, even if the camera is switched off and on again in the meantime.

# SHOOTING MODES

## CONTINUOUS SHOOTING

The camera is set to single shots by default (**Single**). Series of shots can also be created to e.g. capture motion sequences at various stages.

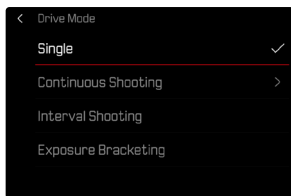

- Select **Drive Mode** in the main menu
- Select **Continuous Shooting**
- Select the desired setting  
(**2 fps, 14 bit, AF**, **4 fps, 14 bit, AF**, **5 fps, 12 bit, AF**,  
**7 fps, 14 bit**, **9 fps, 12 bit**, **15 fps, 12 bit**)

Once you have finalized your settings, the camera will do continuous shootings as long as you keep the shutter button pressed down fully (and you have sufficient space on your memory card).

## Notes

- We recommend deactivating the preview mode (**Auto Review**) when using this function.
- Regardless of how many frames were taken in a series, the last image in the series or the last image saved on the memory card while the saving process is ongoing will be displayed first in both review modes.
- Continuous shooting is not possible if a flash is used. Only a single shot will be taken if the flash function is activated.
- Continuous shooting mode is not available in combination with the self-timer function.
- The buffer memory of the camera only allows a limited number of frames in series and in the selected exposure frequency. The exposure frequency is reduced, once the capacity limit of the camera's buffer memory is reached. This slow-down is due to the time required to transfer the data from the buffer memory to the card. The remaining number of exposures is displayed at the bottom right.
- The following applies for continuous shooting with 2 fps, 4 fps and 5 fps:  
Automatic settings (exposure settings in operating modes **P/A/S**, automatic white balance and autofocus) are implemented individually for each frame.
- The following applies for continuous shooting with 7 fps – 15 fps:  
Automatic settings (exposure settings in operating modes **P/A/S**, automatic white balance and autofocus) are implemented for the first frame, and are then applied for each subsequent frame in the same picture series.

## INTERVAL SHOOTING

This camera allows you to automatically capture motion sequences over extended periods of time using the interval shooting function. You specify the number of frames, the intervals between shots, and the start time of the series.

When applying exposure and focus settings, keep in mind that conditions may change during the course of the operation.

### SPECIFYING THE NUMBER OF FRAMES

- Select **Drive Mode** in the main menu
- Select **Interval Shooting**
- Select **Number of Frames**
- Enter the desired value

### SPECIFYING THE INTERVALS BETWEEN SHOTS

- Select **Drive Mode** in the main menu
- Select **Interval Shooting**
- Select **Interval**
- Enter the desired value

### SETTING THE DELAY TIME

- Select **Drive Mode** in the main menu
- Select **Interval Shooting**
- Select **Countdown**
- Enter the desired value

### Important

- Always choose an interval approx. 1-2 seconds longer than the set exposure time. That will ensure that each frame is shot at the desired interval. Where exposure time is set to be longer than the interval, the camera will shift the next frame automatically to the next interval.

## Getting started

- Press the shutter button
  - The LCD panel will switch off automatically between recordings. Tapping the shutter button reactivates the LCD panel.
  - The remaining time until the next shot and its sequential number is displayed.



### Cancelling a running series of shots

- Press the **PLAY** button
  - A small menu appears.
- Select **End**



## Notes

- The use of autofocus in interval shooting may result in not all exposures having their focus on the same object.
  - The camera may switch off and on again if "Auto power off" is set and no other camera operation occurs between the individual shots.
  - Interval shooting over an extended period of time in a cold location or in a place with high temperature and humidity may result in malfunctions.
  - Interval shooting will be interrupted or canceled in the following situations:
    - if the battery is depleted
    - if the camera is switched offMake sure to check the battery for sufficient charge.
  - Interrupted or canceled interval shooting can be resumed by switching the camera off, replacing the battery or memory card as needed and then switching the camera back on. A prompt will be displayed on screen if the camera is switched off and on again while the **Interval Shooting** shooting function is active.
  - The interval function remains active after the shoot, and also after the camera is switched off and on again, until another shooting mode (Drive Mode) is set.
  - Availability of the interval function does not mean that the camera is suitable for use as a monitoring device.
  - Regardless of how many frames were taken in a series, the last image in the series or the last image saved on the memory card while the saving process is ongoing will be displayed first in both review modes.
  - The shots of an interval shooting are marked with  in review mode.
- The camera may under some circumstances be unable to take good pictures. That may happen if, for example, focusing was unsuccessful. In that case, the camera will not take a picture and the series will continue with the next interval. The message **Some Frames are dropped** appears on screen.

## EXPOSURE BRACKETING

Many attractive objects are rich in contrast, which means they have very bright and very dark areas. The image effect can be dramatically different, depending on which of these areas you choose to align your exposure with. The automatic bracketing function in aperture-priority mode allows you to produce several alternatives with graduated exposure values and varying shutter speeds. You can then select the image you like best or use relevant photo editing software to calculate an image with a particularly broad contrast spectrum (HDR).

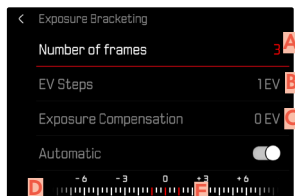

- A** Number of frames
- B** Exposure difference between shots
- C** Exposure compensation
- D** Light value scale
- E** Exposure values of the images marked in red (The scale will be offset by the relevant value if exposure compensation is set concurrently.)

You can select the desired number of frames (3 or 5). The exposure difference, which can be set via **EV Steps**, can be up to 3 EV.

- Select **Drive Mode** in the main menu
- Select **Exposure Bracketing**
- Select the desired number of frames under **Number of Frames** in the submenu
- Select the desired exposure offset under **EV Steps** in the submenu
- Select the desired **Exposure Compensation** value in the submenu
  - The marked exposure values change positions according to the settings selected. In the case of exposure compensation, the scale also shifts.
  - The selected exposure compensation value will be applied to the entire series of shots.
- Select the desired setting under **Automatic** in the submenu
  - With the factory setting in place (**On**), the entire exposure series will run after the shutter button is pressed once; when the setting is **Off**, each picture must be taken individually.
- Take one or several shots by pressing the shutter button

## Notes

-  appears on the LCD panel if the bracketing function is activated. You can watch the effect of the function on screen during shooting (brighter or darker).
- Depending on the exposure mode, the exposure gradations are produced by changing the shutter speed and/or aperture value:
  - Shutter speed (**A/M**)
  - Aperture (**S**)
  - Shutter speed and aperture value (**P**)
- The sequence of shots: underexposure/correct exposure/overexposure.
- The working range for automatic bracketing may be limited depending on the available shutter speed/aperture combination.
- With automatic ISO sensitivity control enabled, the sensitivity calculated by the camera automatically for the raw files will also be applied to all other shots in the series, i.e. the ISO value will not change during bracketing. This may mean that the slowest shutter speed specified under **Shutter Speed Limit** is exceeded.
- The working range for automatic bracketing may be limited (depending on the originally set shutter speed). The specified numbers of frames will be taken regardless. Several shots in a series may consequently have the same exposure values.
- The function remains active until another function is selected from the **Drive Mode** submenu. If no other function is selected, another bracketing is taken each time the shutter button is pressed.

## SELF-TIMER

The self-timer function allows shoot with a preset time delay. We recommend that the camera is placed on a tripod.



- Select **Self-timer** in the main menu
- Select the desired setting  
(**Self-timer 2 s**, **Self-timer 6 s**, **Self-timer 12 s**, **Self-timer 30 s**)
- Shutter release
  - The remaining time until exposure is counted down on the LCD panel. The self-timer LED at the front of the camera counts down the delay time. It flashes slowly during the first 10 s, then fast for the last 2 s.
  - The self-timer delay time can be canceled at any time by tapping the shutter button; the relevant settings remain intact.

## Notes

- Exposure metering is done first; in autofocus mode, focusing is first. Only then will the delay time commence.
- The self-timer function is available only for single frame shooting and for bracketing.
- The function remains active until another function is selected from the **Self-timer** submenu.

# SPECIAL SHOOTING MODES

## DIGITAL ZOOM

Several other cropped section sizes are available in addition to the APO-Summicron 43 f/2 ASPH. image sections. These are similar to the focal lengths 60 mm, 75 mm, 90 mm, 120 mm or 150 mm.

A frame appears around the image section on screen, indicating the final image size. The magnification level is displayed as an equivalent focal length, i.e. the system displays the focal length corresponding to the image section shown.

Factory setting: **43 mm** (no Digital Zoom)

## PERMANENT SETTING

Der menu item **Digital Zoom** can be assigned to the Control Center (see p. 45).

- Assigning the menu item **Digital Zoom** to the Control Center
- Select **Digital Zoom** in the Control Center
- Select the desired setting  
(**60 mm**, **75 mm**, **90 mm**, **120 mm**, **150 mm**)

## DIRECT ZOOM CHANGE

The zoom level can be switched quickly if the **Digital Zoom** function is assigned to a function button.

- Press the function button with the **Digital Zoom** assignment
  - In the factory setting, that will be the FN Button 1 (**13**).
  - A frame appears around the image section on screen, indicating the final image size.
  - The display cycles through the magnification factors each time the button is pressed.
  - The set level will remain until the next change.

Digital Zoom	In shooting mode	In Review mode
Digital Zoom 60 mm		
Digital Zoom 75 mm		
Digital Zoom 90 mm		
Digital Zoom 120 mm		
Digital Zoom 150 mm		

## LIMITING DIGITAL ZOOM LEVELS

The Digital Zoom levels available for selection can be limited as needed. That allows for quicker changes between desired Digital Zoom levels.

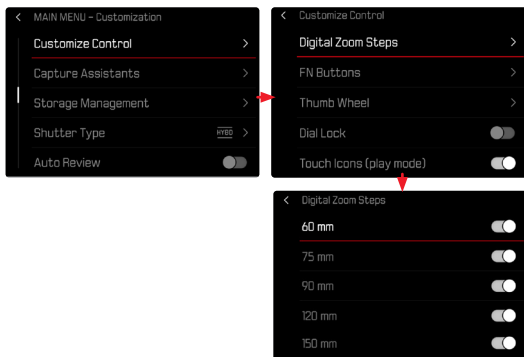

- Select **Customize Control** in the main menu
- Select **Digital Zoom Steps**
- Activating/Deactivating Digital Zoom levels (60 mm, 75 mm, 90 mm, 120 mm, 150 mm)

### Note

- These Digital Zoom limits will be saved individually for Photo and Video mode.

## EFFECT ON THE RESULTING IMAGES

The Digital Zoom will have differing effects on the resulting files, depending on the selected file format.

### DNG IMAGES

DNG files are always saved unchanged (at full size). The relevant information is written to the meta data. The images appear cropped when they are opened in an image editing software, but can be reset to their full size. That will allow a later editing of the full image. In Review mode, the entire picture is shown in the camera, and a frame marks the image section captured with Digital Zoom.



## JPG IMAGES

Only an enlarged cropped section will be displayed and stored for JPG files. The image areas outside the frame are “cropped”. This operation cannot be reversed.

A higher zoom value means a lower resolution as shown in the following table. Cropped sections can also be created using editing software.

Digital Zoom	JPG Resolution		
	L-JPG	M-JPG	S-JPG
Off (43 mm)	60 MP	36 MP	18 MP
60 mm	31 MP	19 MP	9 MP
75 mm	20 MP	12 MP	6 MP
90 mm	14 MP	8 MP	4 MP
120 mm	8 MP	5 MP	2 MP
150 mm	5 MP	3 MP	2 MP

### Note

- The stated resolution will always relate to an aspect ratio of 3:2.

## SCENE MODE

10 automatic program variants are available under the menu item **Scene Modes**. All 10 offer automatically controlled shutter speed and aperture for extra easy photography (as with the “normal” automatic program **P**), as well as a number of other functions to suit the selected scene type. These may include the ISO setting or focusing.

- Select **Scene Mode** in the main menu
- Select the desired setting

- **AUTO**: Automatic snapshot function for general use
- 9 scene modes, which are designed to accommodate the requirements of common object types:
  - **Sports**, **Portrait**, **Landscape**, **Night Portrait**, **Snow / Beach**, **Fireworks**, **Candlelight**, **Sunset**, **Digiscoping**

The following sections offer detailed information about these three functions.

### Notes

- The selected program will remain active until a different program is selected (even after the camera is switched off).
- The menu item Scene Mode will reset to **P-A-S-M** if the shooting mode is changed (Photo/Video).
- The program shift function and some of the menu items are unavailable.
- The shutter-speed dial and the aperture ring are without function.
- A fixed camera setup on a tripod is recommended for the **Digiscoping** setting.
- Exposure preview (see p. 107) is active in all programs.

## PERSPECTIVE CONTROL

This assist function displays a frame showing the expected cropped section of the image after a correction of the perspective of vertical falling lines. Perspective Control helps to achieve a generally straighter vertical line and straight horizon, which ensures a natural image effect, specifically in architectural images.

The function "Perspective Control" calculates the image section and the required distortion correction based on the actual panning angles of the camera and the lens used. In effect, the camera orientation during shooting (determined by internal camera sensors) is the decisive factor and not the lines visible in the image object. The function is therefore unlike automatic perspective control features used for post-editing, which are generally based on the image content.

The functionality depends on the image file format used (JPG or DNG). For JPG format images, the correction occurs directly in the camera and the corrected image is stored. For DNG format images, the relevant information is written to the meta data of the original image. Image correction is done later on using a program like Adobe Photoshop Lightroom® or Adobe Photoshop®\*. Factory setting: **Off**

## Notes

- In case of large panning angles, the distortion correction needed for a complete perspective control would be too extreme. That is why this function is automatically skipped or only partially used where angles are too large. In that case, we recommend creating DNG format images and effecting the desired corrections in a post-editing step.
- A histogram will not be available for technical reasons, while the function **Perspective Control** is active.

This function can only be used in Live View mode.

- You may have to activate Live View
- Select **Perspective Control** in the main menu
- Select **On**

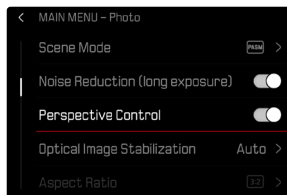

\* See p. 98 for more information.

## DETECTED PERSPECTIVE IN LIVE VIEW MODE

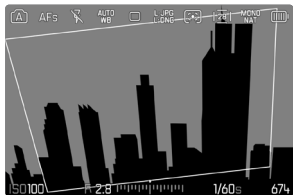

## CORRECTED PERSPECTIVE IN REVIEW MODE



## JPG FORMAT IMAGES

For JPG format images, the correction occurs directly in the camera and only the corrected image is stored. Any image content outside the frame will be lost.

## DNG FORMAT IMAGES

In DNG format, the entire sensor image is stored unchanged. The data calculated by Perspective Control is written to the meta data of the image. Image correction is done later, using appropriate software like Adobe Photoshop Lightroom® or Adobe Photoshop®. A corrected preview version of the image (thumbnail) is displayed in review mode. The same applies for automatic review directly after the image is taken.

In contrast, the original image will usually appear when opening the file in Adobe Photoshop Lightroom® or Adobe Photoshop®. Depending on the default settings of the software, the image can also be directly displayed with the corrections from the auxiliary frame.

## PERSPECTIVE CONTROL IN ADOBE LIGHTROOM® AND ADOBE PHOTOSHOP®

Perspective Control can be done as part of the post-editing process for DNG format images using e.g. Adobe Photoshop Lightroom® or Adobe Photoshop®. Read the Adobe Online Help for more detailed information about the topic.

### ADOBE LIGHTROOM®:

<https://helpx.adobe.com/en/lightroom-classic/help/guided-upright-perspective-correction.html>

### ADOBE PHOTOSHOP®:

<https://helpx.adobe.com/en/photoshop/using/perspective-warp.html>

## CORRECTION AND DISPLAY OF AUXILIARY LINES

Select the function “With auxiliary lines” under “Geometry” > “Upright” to apply the correction defaults of the camera and display the auxiliary lines.

Correction will automatically applied if the RAW default setting “Camera Settings” is selected.

Correction can be disabled under “Upright” at any time.

<https://helpx.adobe.com/en/photoshop/kb/acr-raw-defaults.html>

→ Select “Camera Settings” as the RAW default setting

## FLASH PHOTOGRAPHY

The camera determines the necessary flash intensity by firing one or more pre-flashes before taking the actual photo. The main flash fires immediately after, i.e. during exposure. All factors influencing exposure (e.g. filters, aperture settings, distance to the main subject, reflective ceilings, etc.) are automatically considered.

## COMPATIBLE FLASH UNITS

The full functional scope described in this instruction manual, including TTL flash exposure is available only in conjunction with Leica system flash units like the SF 40, or devices by Profoto. Other flash units, which only have a positive center contact, can be safely fired via the Leica Q3 43, but cannot be controlled via the camera. Correct function cannot be guaranteed when using any other flash unit.

### Important

- The use of incompatible flash units with your Leica Q3 43 may result in irreparable damage to the camera and/or the flash unit.

### Notes

- A flash unit that is not ready to flash may cause incorrect exposures or error messages.
- Studio flash systems may have a very long flash firing duration. It may therefore be advantageous to select a slower shutter speed than 1/200 s when using such a system. The same applies for RF-controlled flash firing for so-called “off-camera” flashes, as the transmission time may cause a delay.
- Continuous shooting and automatic bracketing with flash are not available.
- Use a tripod to prevent blurring at slow shutter speeds. Alternatively, you can select a higher sensitivity.

## ATTACHING THE FLASH UNIT

- Switch off the camera and flash unit
- Pull off the accessory shoe cover and store it in a safe place
- Slide the foot of the flash unit all the way into the accessory shoe and use the clamping nut (where available) to secure it against accidental movement
  - Movement inside the accessory shoe can interrupt required contacts and therefore cause malfunctions.

## DETACHING THE FLASH UNIT

- Switch off the camera and flash unit
- Release the lock as needed
- Detach the flash unit
- Replace the accessory shoe cover

### Note

- Make sure that the accessory shoe cover is always in place when no accessory is attached (e.g. a flash unit).

## FLASH EXPOSURE METERING (TTL METERING)

The camera-controlled, fully automatic flash mode is available in this camera in conjunction with system-compatible flash units (see p. 121), and in both exposure modes (Aperture-priority Mode and Manual).

In aperture-priority mode and with manual setting, the camera furthermore allows the use of other interesting flash techniques like flash synchronization and firing with slower shutter speeds than the max. sync time.

The camera additionally communicates the sensitivity setting to the flash unit. The flash unit can use this information to automatically adjust its range data, provided the device comes with these displays and the aperture setting selected on the lens is also entered manually on the flash unit. The ISO sensitivity setting cannot be altered via the flash unit on system-compatible units, because the information is received from the camera.

## SETTINGS ON THE FLASH UNIT

Operating mode	
<b>TTL</b>	Automatic control by the camera
<b>A</b>	SF 40, SF 60: Automatic camera control, no flash exposure compensation SF 58, SF 64: Control via the flash unit using a built-in exposure sensor
<b>M</b>	The flash exposure must be set to an output level to match the aperture and shutter speed settings determined by the camera.

### Notes

- Set the flash unit to **TTL** mode to allow automatic control of the unit by the camera.
- When set to **A**, objects with above or below average brightness may not be exposed correctly.
- Please read the relevant manual provided with third party flash units regarding their various operating modes.

## FLASH MODES

Select one of the three available operating modes.

- Automatic
- Manual
- Long-term exposure

### **A** AUTOMATIC FLASH ACTIVATION

That is the default flash mode. The flash unit will fire automatically if poor lighting conditions would mean slower shutter speeds, which could result in blurred images.

### **M** MANUAL FLASH ACTIVATION

This mode is suitable for backlit pictures in which the main subject does not fill the entire frame and is in shadow, or in situations where a fill-in flash will moderate sharp contrasts (e.g. in direct sunlight). The flash will fire each time a picture is taken, regardless of prevailing lighting conditions. The flash intensity depends on the metered ambient brightness: in poor light it is the same output as in automatic mode, with output decreasing with increasing brightness. The flash will then work as a fill-in light, e.g. to light up dark shadows in the foreground or backlit objects, and to create more balanced overall lighting.

## **AUTOMATIC FLASH ACTIVATION AT SLOWER SHUTTER SPEEDS (LONG-TERM SYNCHRONIZATION)**

This mode ensures appropriately exposed, brighter dark backgrounds and bright foreground.

The shutter speed is not extended beyond 1/30 s in the other flash modes to minimize the risk of blurring. This may mean, however, that pictures with flash exposure can end up with objects in the background not illuminated by the flash and therefore being underexposed. In this mode, slower shutter speeds (up to 30 s) are permitted to avoid this effect.

- Select **Flash Settings** in the main menu
- Select **Flash Mode**
- Select the desired setting
  - The currently active mode is displayed on screen.

## **FLASH CONTROL**

The settings and functions described in the following sections only apply to settings and functions available in this camera and in system-compatible flash units.

### **SYNC POINT**

Flash exposures are lit by two light sources:

- existing light from the environment
- the additional flash

Any subject elements lit primarily by the flash will almost always be rendered in perfect focus by the short burst of light, provided the focus is set correctly. All other subject elements in the same frame lit by ambient light or lit from within will be rendered with varying degrees of sharpness. Whether or not these object elements will be rendered in sharp focus or blurred, as well as the degree of “blurriness” depends on two interdependent factors:

- the shutter speeds
- the speed of movement of the subject elements or camera during shooting

The longer the shutter speed and the faster the motion, the greater the difference between the two superimposed partial images.

A flash is usually fired at the start of exposure (**Start**). This may result in apparent contradictions, e.g. the image of a vehicle being overtaken by its own light trail. This camera alternatively allows synching with the end of exposure (**End**). The sharp image will in this case be a rendering of the end of the captured motion. This flash technique creates a more natural impression of movement and dynamics in the image.

This function is available with all camera and flash unit settings.

Factory setting: **End**

- Select **Flash Settings** in the main menu
- Select **Flash Sync**
- Select the desired setting (**Start**, **End**)
  - The set sync point is shown in the header line.

## Notes

- Do not use sync cables that are longer than 3 m.
- When using the flash with faster shutter speeds, a difference between the two flash firing points will be barely discernible or only noticeable for very fast movements.

## FLASH RANGE

The usable flash range depends on the aperture and sensitivity values set manually or calculated by the camera. It is important to ensure that the subject is within the relevant flash range for sufficient illumination. A permanent setting to the shortest available shutter speed for flash mode (sync time) may often result in unnecessary underexposure of those subject elements that are not lit sufficiently by the flash.

This camera allows the fine tuning of the shutter speed used in flash mode in combination with aperture-priority mode depending on the conditions of the object or your own pictorial composition ideas.

Factory setting: **Auto**

- Select **ISO Settings** in the main menu
- Select **Auto ISO Settings**
- Select **Shutter Speed Limit (Flash)**
- Select the desired value (**Auto**, **1/2000**, **1/1000**, **1/500**, **1/250**, **1/125**, **1/60**, **1/30**, **1/15**, **1/8**, **1/4**, **1/2**)

## FLASH EXPOSURE COMPENSATION

This function can be used to selectively reduce or enhance flash exposure regardless of ambient light, e.g. to brighten the face of a person in the foreground when taking a photo outdoors in the evening while retaining the same general lighting mood.

Factory setting: **0 EV**

- Select **Flash Settings** in the main menu
- Select **Flash Exp. Compensation**
  - The submenu displays a scale with a red setting mark. The function is deactivated if the value is set to **0**.
- Set the value on the scale
  - The set value is displayed above the scale.

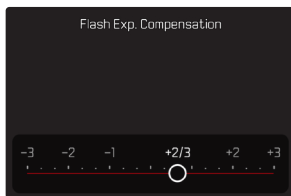

## Notes

- The following applies for set compensation values, no matter how they were initially set: They remain effective until they are manually reset to **0**, even if the camera is switched off and on again in the meantime.
- The menu item **Flash Exp. Compensation** can only be used in conjunction with flash units on which the compensation value cannot be set manually (e.g. Leica SF 26).
- **Flash Exp. Compensation** is unavailable, if flash units with an own compensation function are used (e.g. Leica SF 58 or Leica SF 60). A compensation value set on the camera would in that case have no effect.
- A brighter flash illumination with Plus compensation will require a greater flash intensity. Flash exposure compensation will therefore impact on the flash range: A Plus correction will decrease it, a Minus correction will increase it.
- An exposure compensation set on the camera will only affect the measurement of ambient light. If a simultaneous TTL flash exposure metering compensation is desired in flash mode, then it must be additionally set on the flash unit.

## FLASH PHOTOGRAPHY

- Switch on the flash unit
- Set the desired guide number control mode (e.g. TTL or GNC = Guide Number Control) on the flash unit
- Switch the camera on
- Select the desired exposure mode, shutter speed and/or aperture setting
  - It is imperative to take note of the shortest flash sync speed, as it determines whether a “normal” flash or an HSS flash is fired.
- Tap the shutter button before each flash exposure to activate exposure metering
  - The flash unit may not fire if this step is missed by pressing the shutter button down completely and skipping these settings.

### Note

- We recommend not using **Spot** as your exposure metering method for flash photography.

## REVIEW MODE

There are two completely independent review functions available:

- short-term rendering directly after shooting (Auto Review)
- normal review mode, in which the stored images can be viewed and managed for any length of time

The switchover between shooting and review mode, as well as most other actions can be completed using gesture or key control. Please see p. 41 for more information about the available gestures.

### Notes

- Recorded images are not automatically rotated in review mode to utilize the full screen area.
- It may not be possible to render files with this camera that were not recorded with this device.
- In some cases, the screen image may not have the expected quality, or the LCD panel will remain blank and only display the file name.
- You can toggle back from review mode to shooting mode at any time by tapping the shutter button.
- The histogram and clipping displays are available only when viewing the full size picture, but not during zooming or in the overview.

## CONTROL ELEMENTS IN REVIEW MODE

### CONTROL ELEMENTS ON THE CAMERA

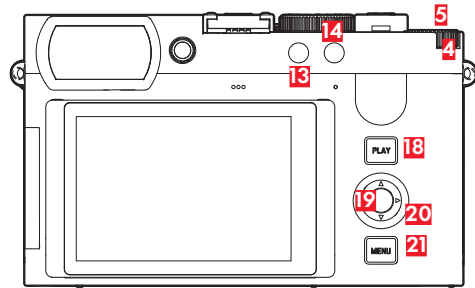

- |           |                   |           |                 |
|-----------|-------------------|-----------|-----------------|
| <b>4</b>  | Thumbwheel        | <b>18</b> | PLAY button     |
| <b>5</b>  | Thumbwheel button | <b>19</b> | Center button   |
| <b>13</b> | FN button 1       | <b>20</b> | Directional pad |
| <b>14</b> | FN button 2       | <b>21</b> | MENU button     |

## DIRECT ACCESS IN PLAYBACK MODE

The function buttons can have individual assignments in review mode as well.

In factory settings, the function buttons have the following assignments:

Button	Function
Thumbwheel button (5)	Mark shots (Rate / Unrate)
FN button (13)	Delete Single
FN button (14)	Magnification
Center button (19)	Toggle Info Levels

The descriptions in the next few sections presume factory settings.

### Notes

- The assigned function is independent of the current display mode; the delete functions overview can therefore be accessed directly in full screen display mode.
- The assigned function is unavailable if the function button addresses an on-screen control element (e.g. in the "Delete" screen).

## CONTROL ELEMENTS ON THE LCD PANEL

On-screen control elements generally function by intuitively by touch. Many can also be selected by pressing one of the three buttons to the right of the LCD panel (**PLAY** button, center button, **MENU** button).

You have e.g. two options to select the Favorites icon ★:

- Tap on the Favorites icon directly
- press the relevantly assigned button

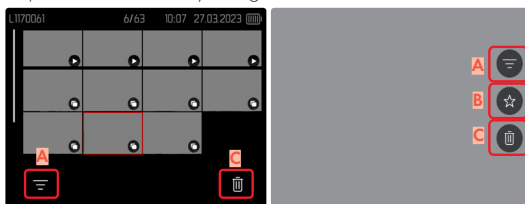

- A Control element "Filter"
- B Control element "Favorites"
- C Control element "Delete"

## HIDING CONTROL ELEMENTS

- Select **Customize Control** in the main menu
- Activating/Deactivating **Touch Icons (Play mode)**

# STARTING/EXITING REVIEW MODE

## Using touch control

→ Swipe down

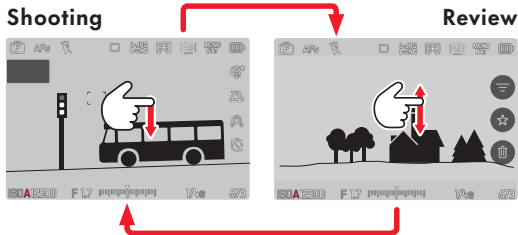

## Using button control

→ Press the **PLAY** button

- The last captured image appears on the screen.
- The message **No valid picture to play** appears if the inserted memory card does not contain any image data.
- The **PLAY** button function differs, depending on the current camera setting

Initial situation	After pressing the <b>PLAY</b> button
Full screen display of a recording	Shooting mode
Display of an enlarged cropped section/or several thumbnails	Full screen display of the image

## SELECTING/SCROLLING THROUGH IMAGES

The images are visually arranged in a horizontal reel. The sorting will be strictly chronological. When the end of an image series is reached, the display automatically jumps back to the first image in the series. All images can therefore be reached by scrolling either right or left.

### SINGLE

Using touch control

→ Swipe to the left or right

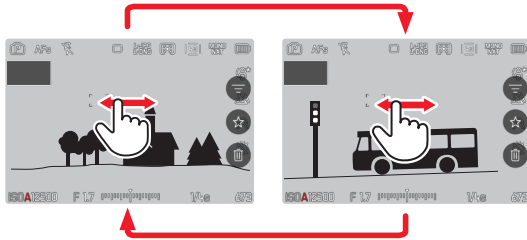

Using button control

→ Press the directional pad left/right

## CONTINUOUS

- Swipe to the left or right and hold the finger on the edge of the screen
  - The subsequent shots will move past continuously.



## INFO DISPLAYS IN REVIEW MODE

The same info profiles are available in playback mode as in shooting mode. The actual info profile currently in use, however, is saved separately. It is therefore possible to use an empty info profile completely without assist function icons in review mode, without having to set them again when switching to shooting mode. The assist functions **Grids**, and **Level Gauge** are not displayed in review mode.

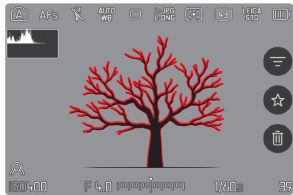

Info Bars



Empty info profile

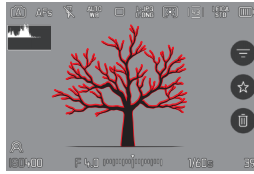

Info Bars, Focus Peaking, Histogram

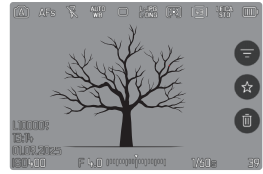

Info Bars, file information

### Switching between info profiles

→ Press the center button

- The info bars appear (header and footer line always appear/disappear together in review mode).
- The displays for **Histogram** and **Clipping** will appear if these functions are activated.

## PICTURE SERIES REVIEW

Serial and interval shootings often produce a large number of individual images. It would be very difficult to find other pictures that are not part of a series if every image of all these series was displayed individually. Organizing the images in groups creates more clarity in review mode.

Factory setting: **On**

→ Select **Group Display Mode** in the main menu

→ Select **On** or **Off**.

All images in all series are displayed individually if **Off** is selected. The images are grouped in series and only one representative image will be displayed if **On** is selected. Only that one representative image will be displayed and all other images in that series are hidden during scrolling.



The representative image is shown with **▶** in the center and **📁 1/17** on the left.

There are two options for viewing the images in a group: manual scrolling or automatic playback. Automatic review is the default setting.

## UNINTERRUPTED PLAYBACK OF THE PICTURE SERIES

The images in a group can be played back from start to finish without interruption. This may be very helpful to get a better idea of the processes or conditions rendered than if the images were scrolled manually.

→ Tap **▶**

or

→ Press the center button

- Auto Review commences.

## PAUSE PLAYBACK

→ Tap anywhere on the LCD panel

or

→ Press the center button

- Playback stops, the current picture in the series is displayed.

## RESUMING PLAYBACK

While the control elements are visible:

→ Tap anywhere on the LCD panel

or

→ Press the center button

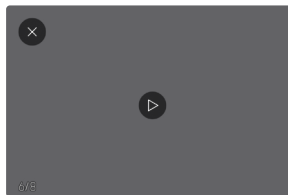

## SAVE AS A VIDEO

The frame series can additionally be saved as a video.

- Starting and stopping review
- Press the **MENU** button
- Select **Yes/No**
  - **Yes:** A video is created
    - A progress screen for the video creation is displayed briefly (while the data is being processed). It also offers the option of canceling the process by pressing the center button.
    - Once video creation is complete, the first frame of the new video is displayed.
  - **No:** Revert to the same picture of the (still paused) automatic review

## SCROLLING THROUGH THE INDIVIDUAL PICTURES OF A SERIES

The images in a picture series can also be viewed individually. Switch to the manual scrolling function to do so.





- Press the directional pad up/down
    - The information displays disappear in full-screen mode.
    - Activated information displays will show information in the image on the left.
  - Press the directional pad left/right
- or
- Swipe left

## Returning to standard review mode

- Press the directional pad up/down

## Notes

- The review will be limited to the current picture series while you are scrolling in that series. The same applies for the overview with 9 or 16 thumbnails.
- The images of a series are marked with  in the header line, those of an **Interval Shooting** shoot by a .

## CROPPED SECTION ZOOM

You can zoom in to any section of an image for closer inspection. You have a five-step zoom factor available via the thumbwheel, while zooming is stepless if you use touch control.

### Using touch control

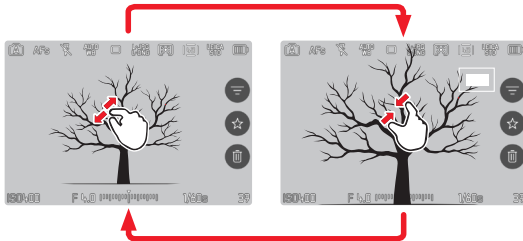

#### → Two-finger pinch/spread

- The image will be zoomed in/zoomed out at the desired point.

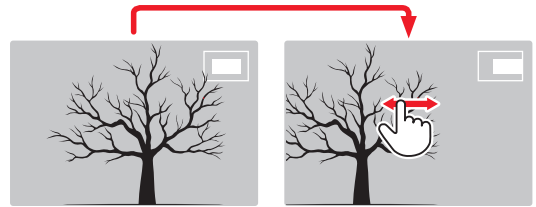

- Move the position of an enlarged cropped section by swiping
  - The rectangle within the frame at the top right represents the current magnification, as well as its position in the displayed cropped section.



#### → Double tap

- Toggles between the third zoom increment at the tap position and standard full screen view.

### Using button control

→ Turn the thumbwheel  
(to the right: increase magnification, to the left: decrease magnification)

or

- Press the thumbwheel button
  - Toggles between the third zoom increment at the tap position and standard full screen view.
- Press the directional pad to move the enlarged section anywhere in the image
  - The rectangle within the frame at the top right represents the current magnification, as well as its position in the displayed cropped section.

You can move directly from one image to the next in magnification mode, which will then also be displayed with the same magnification.

- Press and hold the **PLAY** button while turning the thumbwheel

### **Notes**

- It may not be possible to enlarge images taken with other camera types.
- Video recordings cannot be enlarged.

## DISPLAYING MULTIPLE IMAGES AT ONCE

The camera offers an overview function in which several thumbnail images can be viewed on one screen, which makes it easier to find a specific image. Choose to display 9 or 16 thumbnails for your overview.

### OVERVIEW

#### Using touch control

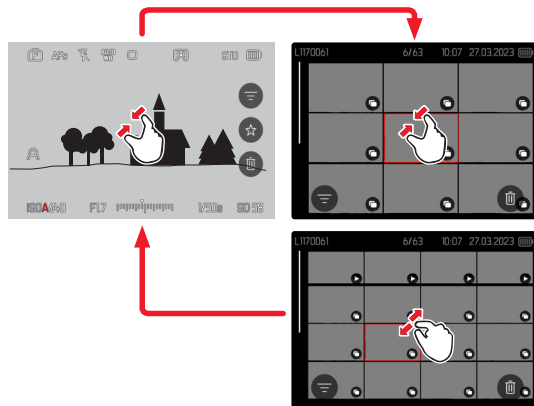

- Two-finger pinch
  - The display toggles between 9 or 16 thumbnails.

## Viewing other recording

→ Swipe up or down

### Using button control

→ Turn the thumbwheel to the left

- An overview with 9 thumbnails is displayed.  
Another turn on the dial increases the number of displayed thumbnails to 16.

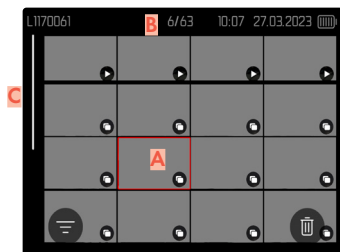
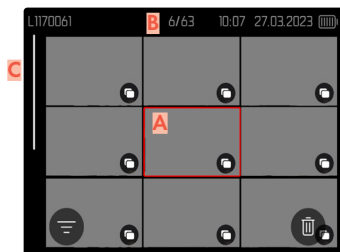

- A** Currently selected image
- B** Number of the currently selected images
- C** Scrollbar

The currently viewed image is framed in red and can be selected for a closer look.

## Navigating between recordings

→ Press the directional pad in the relevant direction  
or

→ Turn the thumbwheel

## Displaying the image in full size

### Using touch control

→ Two-finger spread

or

→ Tap the desired image

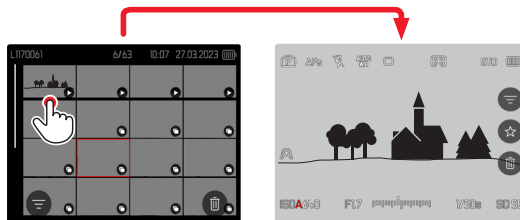

### Using button control

→ Turn the thumbwheel to the right

or

→ Press the center button or the **PLAY** button

## TAGGING/RATING OF IMAGES

Recordings can be marked as favorites to find them quicker or to simplify the later deletion of multiple recordings. Tagging can be done in regular view mode or in the overviews.

### Tagging a photos

→ Press the thumbwheel button

or

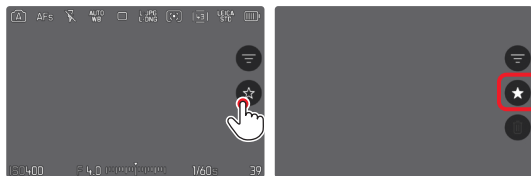

→ Tap the ★ icon

- The ★ icon is highlighted.
- The icon will appear on the far right when viewing images in full size, and in the lower left corner of the thumbnail overview.

### Removing a tag

→ Press the thumbwheel button

or

→ Tap the ★ icon

## DELETING IMAGES

There are several methods available to delete images:

- deleting individual images
- deleting multiple images
- deleting all images without a icon/ranking
- deleting all images

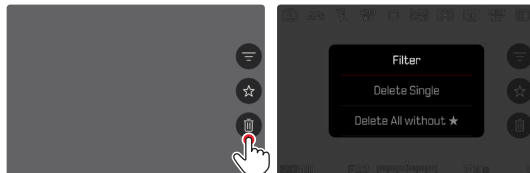

### Important

- Once deleted, images are no longer retrievable.

## DELETING INDIVIDUAL IMAGES



→ Tap the Delete  icon

- A confirmation prompt appears.
- The LED will flash during the delete process. The process may take a few seconds.
- The next image will be displayed once deletion is complete. The following message appears if no other images are saved on the card: **No valid picture to play.**

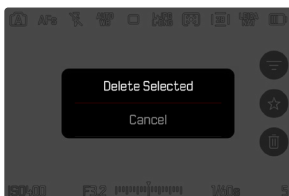

## Cancelling a deletion and returning to normal review mode

→ Press the **PLAY** button

or

→ Select **Cancel**

## DELETING MULTIPLE IMAGES

You can highlight multiple images in a Delete overview with twelve thumbnails for simultaneous deletion.



→ Turn the thumbwheel to the left

- The overview screen appears.

→ Press the **MENU** button

→ Select **Delete Multi**

- The Delete overview appears.
- Any number of images can be selected in this view.

## Selecting images for deletion

- Select a recording
  - Press the directional pad
- or
- Tap the desired image
    - The images selected for deletion are marked.

## Deleting the selected images

- Press the **MENU** button
- Select **Delete Selected**

or

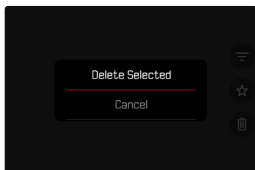
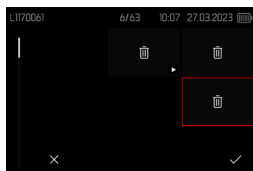

- Tap the “Delete” icon
- Select **Delete Selected**

## Cancelling a deletion and returning to normal review mode

- Press the **MENU** button

## DELETING ALL UNRATED IMAGES

- Press the **MENU** button
- Select **Delete All without ★**

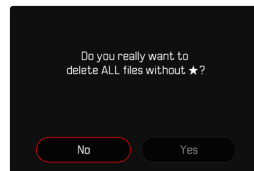
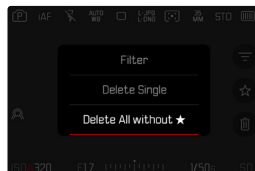

- The confirmation prompt **Do you really want to delete ALL files without ★?** appears.
- Select **Yes**
- The LED will flash during the deletion process. The process may take a few seconds. The next marked recording appears once deletion is complete. The message **No valid picture to play** appears if no other images are saved on the card.

## DELETING PICTURE SERIES

Picture series can be displayed in groups for quick deletion. The pictures will have to be displayed in groups.

- Select **Group Display Mode** in the main menu
- Select **On**

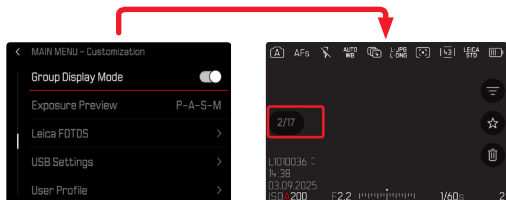

- Select the representative image

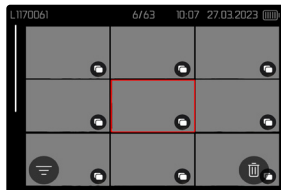

- Delete
  - All pictures in the picture series will be deleted.

## PREVIEW OF LATEST IMAGE

Photos can be displayed automatically directly after they are taken to e.g. check the success of the shots quickly and easily. A duration for the automatic display can be configured.

- Select **Auto Review** in the main menu
- Select **Setting**
- Select the desired function or duration in the submenu (**1 s**, **3 s**, **5 s**, **Permanent**, **Shutter Button Pressed**)

- **Permanent**: The most recent frame is displayed until automatic review is ended by pressing the **PLAY** button or by tapping the shutter button.
- **Shutter Button Pressed**: The most recent frame is displayed for as long as the shutter button is pressed down.

### Notes

- Various control elements change back to regular review mode to execute their normal functions while automatic review is selected. The camera will remain in review mode until it is exited.
- Marking and deleting can only be done in regular review mode and not during automatic review.
- When shooting with the Continuous Shooting or Interval Shooting functions, then the last image in the series will be displayed or – if the save process is still incomplete – the last image in the series saved to the memory card.
- Where display times were configured (**1 s**, **3 s**, **5 s**) automatic review can be ended immediately by pressing the **PLAY** button or tapping the shutter button.

## VIDEO SETTINGS

### FILE FORMAT

Video can be recorded in the file formats MOV or MP4. Various combinations of resolution and frame rate can be configured depending on the file format chosen. This choice allows an alignment with the intended use and available memory card capacity.

### VIDEO FORMAT

The following combinations of resolution and frame rate are available:

#### MOV

Frame rate	Resolution				
	C8K	8K	C4K	4K	FHD
23.98 fps	✓	✓	✓	✓	✓
24 fps	✓	✓	✓	✓	✓
25 fps	✓	✓	✓	✓	✓
29.97 fps	✓	✓	✓	✓	✓
47.95 fps			✓	✓	✓
48 fps			✓	✓	✓
50 fps			✓	✓	✓
59.94 fps			✓	✓	✓
100 fps					✓
119.88 fps					✓

## MP4

Frame rate	Resolution		
	8K	4K	FHD
23.98 fps	✓	✓	✓
25 fps	✓	✓	✓
29.97 fps	✓	✓	✓
50 fps		✓	✓
59.94 fps		✓	✓

## AVAILABLE RESOLUTIONS

You can choose resolutions with the associated aspect ratios.

File Format	Available resolutions	
MOV	C8K	8192 x 4320
MOV + MP4	8K	7680 x 4320
MOV	C4K	4096 x 2160
MOV + MP4	4K	3840 x 2160
MOV + MP4	FHD	1920 x 1080

## AVAILABLE FRAME RATES

Up to 10 different frame rates between 23.98 fps and 119.88 fps are available depending on the selected resolution.

Two frame rates (100 fps and 119.88 fps) allow slow motion recording with four times slower playback (one second of recording equals four seconds of playback).

## SETTING THE VIDEO FORMAT

### Via the Control Center

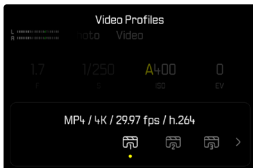
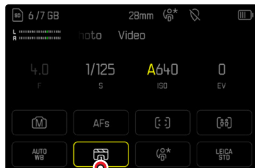

### Via the menu

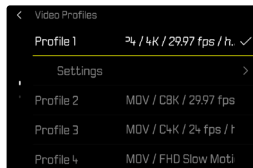
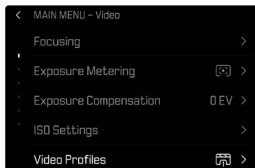

## Profile editing

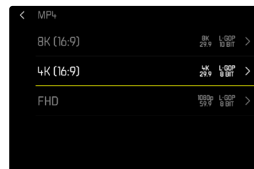
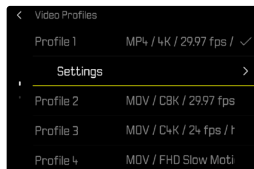

→ Select **Video Profiles** in the main menu

→ Select a profile

→ Select a format

(**MOV**, **MP4**)

→ Select the desired resolution

(**MOV**: **C8K**, **8K**, **C4K**, **4K**, **FHD(ProRes)**, **FHD**, **FHD Slow Motion**)

(**MP4**: **8K**, **4K**, **FHD**)

→ Select the desired frame rate

→ Select **Video Profiles** in the main menu

→ Select a profile

## LEICA LOOKS

The image properties of video recordings can be changes slightly using several parameters. These are summarized in pre-configured **Leica Looks** profiles. Furthermore, additional Leica Looks can be downloaded and transferred via Leica FOTOS.

Pre-installed are:

- **Standard**
- **Vivid**
- **Natural**
- **Monochrome**
- **Monochrome High Contrast**

- Select **Leica Looks** in the main menu
- Select a profile

### Note

- The **Leica Looks** function is unavailable if any other setting but **Off** is selected for **Video Gamma**.

## CUSTOMIZING LEICA LOOKS

Leica Looks are individually customizable.

### LOOKS CONFIGURATION FRAME

Customizable	Only intensity	Not customizable
<b>Core Looks</b> (Standard, Vivid, Natural, Monochrome, Monochrome High Contrast)	<b>Essential Looks</b> (Teal, Chrome, Eternal etc.)	<b>Artist or Partner Looks</b> (Greg Williams)

### Note

- This information may change with the addition of new Leica Looks.

- Select **Leica Looks** in the main menu
- Select a profile
- Select **Customize**
- Select **Contrast/Highlight/Shadow/Sharpness/Saturation**
- Select the desired level  
(-2, -1, 0, +1, +2)
- **Intensity** can be set as a percentage as needed

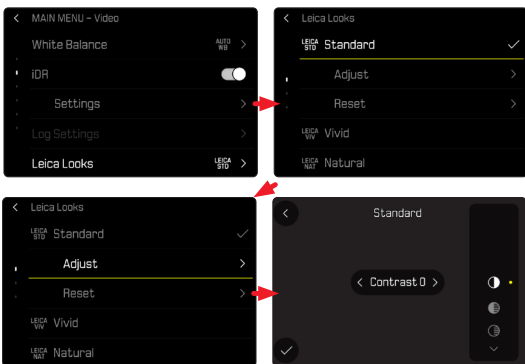

## DOWNLOADING LEICA LOOKS

Additional Leica Looks can be downloaded and transferred via Leica FOTOS.

- Select **Leica Looks** in the main menu
- Select **Download Leica Look**

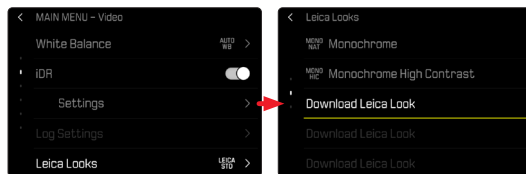

## RESETTING LEICA LOOKS

- Select **Leica Looks** in the main menu
- Select **Restore**

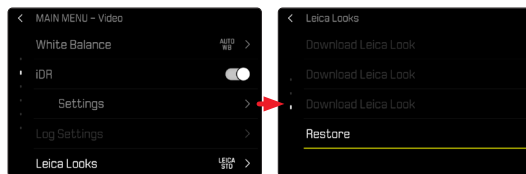

### Note

- Only customizable Leica Looks can be reset.

# AUDIO SETTINGS

## MICROPHONE

The sensitivity of the integrated microphone can be set.  
Factory setting: **0 dB**

Via the Control Center

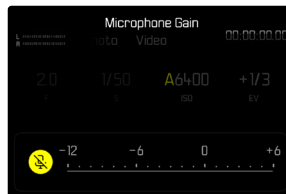
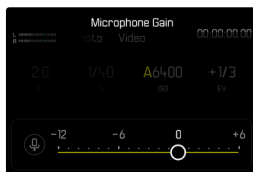
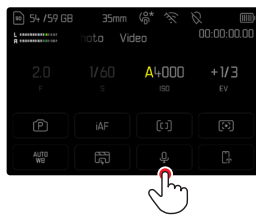

## Notes

- The Autofocus function and manual focusing adjustments generate noise that may be picked up in the recording.
- There will be no audio recorded if this setting is **Off**. As notification, the icon for the recording level changes as shown here .

Via the menu

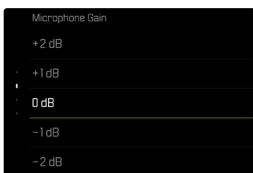
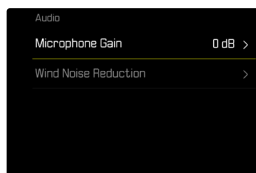

- Select **Audio** in the main menu
- Select **Microphone Gain**
- Select the desired level  
(**Off**, **+6 dB**, **+5 dB**, **+4 dB**, **+3 dB**, **+2 dB**, **+1 dB**, **0 dB**, **-1 dB**, **-2 dB**, **-3 dB**, **-4 dB**, **-5 dB**, **-6 dB**, **-7 dB**, **-8 dB**, **-9 dB**, **-10 dB**, **-11 dB**, **-12 dB**)

## USB AUDIO



The use of an external USB microphone requires an activation of the function via the menu. Once the function **USB Microphone** is activated, the camera will automatically switch from the internal to the external microphone.

Factory setting: **Off**

- Select **USB Settings**
- Select **USB Microphone**
- Select **On**

### Notes

- Should the USB microphone be disconnected during a video recording, then the audio data will not be stored in the video file, even if the USB microphone is reconnected. A relevant warning will be displayed. Where that is the case, the video recording will have to be stopped and restarted.
- The other USB functions like **PTP**, **MFi**, or **Mass Storage** are not available as long as **USB Microphone** is activated in the camera menu.
- The camera will copy identical audio data from single-channel to dual-channel if the USB microphone only supports single-channel data.
- USB microphone requirements: Sampling rate: 48 kHz, Bit depth: 8, 16, 24, 32, Channel: 1, 2
- Compatible RØDE USB audio devices include: VideoMic GO II, VideoMic NTG, Wireless GO II, Wireless ME, and other supported USB microphones.

## WIND NOISE REDUCTION

Wind noise reduction can be adjusted individually for the internal and the external microphone.

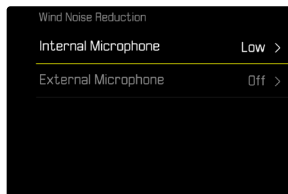

### INTERNAL MICROPHONE

Factory setting: **Low**

- Select **Audio** in the main menu
- Select **Wind Noise Reduction**
- Select **Internal Microphone**
- Select the desired setting (**High**, **Low**, **Off**)

### EXTERNAL MICROPHONE

Factory setting: **Off**

- Select **Audio** in the main menu
- Select **Wind Noise Reduction**
- Select **External Microphone**
- Select the desired setting (**High**, **Low**, **Off**)

## VIDEO GAMMA

Video gamma can be set to HLG and L-Log or can be deactivated altogether.

Off	Optimization for playback compatible with all screen/TV devices in compliance with the BT.709 standard.
HLG	Optimization for HDR-capable UHD-TV devices.
L-Log	Optimization for professional reworking, e.g. color grading.

Factory setting: Off

- Select **Video Profiles** in the main menu
- Select a profile
- Select **Settings**
- Select **Video Gamma**
- Select the desired setting  
(Off, HLG, L-Log)

### Notes

- **Video Gamma** is not available under the following conditions:
  - Recordings in MP4 format
  - Recordings in 8 bit
  - Recordings in slow motion
- The following functions are unavailable when **Video Gamma** is used:
  - **iDR**
  - **Leica Looks**

## HLG SETTINGS

Sharpness and saturation can be set. The factory setting is a median value 0 in both cases.

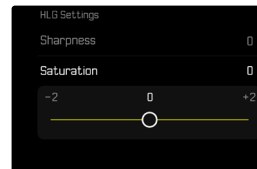
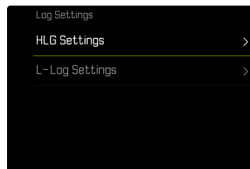

- Select **Log Settings** in the main menu
- Select **HLG Settings**
- Select **Sharpness** or **Saturation**
- Select the desired setting  
(-2, -1, 0, +1, +2)

## L-LOG SETTINGS

The sharpness for L-Log can be adjusted. Additionally, various LUT profiles can be applied as preview when using L-Log. Saved recordings remain unaffected.

### SHARPNESS

Factory setting: **-2**

- Select **Log Settings** in the main menu
- Select **L-Log Settings**
- Select **Sharpness**
- Select the desired setting  
(**-2, -1, 0, +1, +2**)

## SETUP/MANAGEMENT OF LUT PROFILES

You can import custom LUT profiles to the camera to optimally meet your LUT preview expectations.

- Select **Log Settings** in the main menu
- Select **L-Log Settings**
- Select **Custom LUT**
  - A list of six memory slots is displayed. Three are reserved for use with HDMI output, and three for internal camera use (LCD panel/EVF).
  - Filled memory slots will show the name of the saved LUT profile. Free memory slots display the word **Unused**.

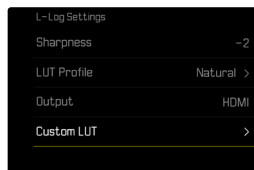

## Importing a custom LUT profile

- Download or export an LUT profile as a CUBE file
- Give the file a meaningful name (file name max. 8 characters, file ending “.cube”)
  - This file name (without the ending) will appear as a profile name in the camera after import. A later file name change on the camera will not be possible.
- Save the download to the memory card
  - Store the file in the main directory of the memory card (not in a sub-directory).
- Insert the memory card into the camera
- Select an unused memory slot
  - You will have to delete an existing profile first if there is no unused memory slot available.
  - The “Import” dialog appears. It displays the files found on the memory card.
  - The message **Import Failed** will appear if the camera does not find a compatible file.
- Select the profile to import
- Select **Yes**

## Notes

- You can only import LUT profiles with the file ending “.cube”.
- Files with the ending “.cube” will not be recognized. These can, however, simply be renamed before saving them to the SD card.
- File names must be max. 8 characters (incl. spaces) long.
- Incompatible files will not be recognized.
- A maximum of six profiles saved to the memory card will be displayed. The profiles found on the card will be displayed chronologically in ascending order: the most recently saved profile will appear at the top.
- In rare cases, a particular combination of memory card and computer may result in a search returning only three profile files.

## Freeing a memory slot

- Select a profile
  - The “Delete” dialog appears.
- Select **Yes**

## Notes

- The pre-configured profiles **Natural** and **Classic** cannot be deleted.
- A profile that is currently in use cannot be deleted.

## USING LUT PROFILES

### CHANGING THE OUTPUT CHANNEL

The user can choose to apply the LUT profile for output via HDMI or in the camera (LCD panel/EVF).

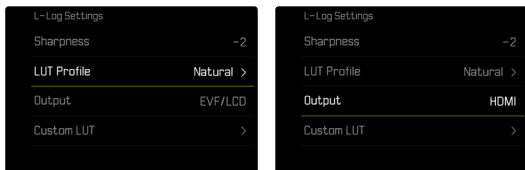

- Select **Log Settings** in the main menu
- Select **L-Log Settings**
- Select **Output**
- Select the desired setting (**EVF/LCD**, **HDMI**)

### Notes

- The menu item **Output** is unavailable if the setting **Off** is selected for **LUT Profile**.
- When toggling between the two output channels, the setting for the selected memory slot will remain unchanged. Since it is possible that different profiles are saved on the same slot depending on the output channel, it is possible that a different profile or an unused memory slot is selected. The name of the active profile will change accordingly next to the menu item **LUT Profile**. This does not apply for the pre-configured profiles, which exist on the same memory slot for both output channels.

## SELECTING THE LUT PROFILE

In addition to the two pre-configured LUT profiles, three more memory slots are available for custom LUT profiles.

- Select **Log Settings** in the main menu
- Select **L-Log Settings**
- Select **LUT Profile**
  - The list of profiles available for the active output channel appears.
- Select the desired setting (**Off**, **Natural**, **Classic**, **LUT 1**, **LUT 2**, **LUT 3**)

### Notes

- Unused memory slots appear in the list as **LUT 1**, **LUT 2**, and **LUT 3**. A memory slot filled with a custom LUT profile will display its name instead.
- The list of selectable LUT profiles depends on the currently selected output channel (camera/HDMI). The channel is displayed next to the menu item **Output**. When the channel is set to **HDMI**, the selection list will display the profiles available for HDMI output. The setting **EVF-LCD** will therefore show the profiles available for camera display.

## AUTOMATIC OPTIMIZATION

### VIDEO STABILIZATION

The stabilization function helps to reduce blurring for handheld recordings.

Factory setting:  On

- Select **Optical Image Stabilization** in the main menu
- Select the desired setting ( On,  Off)

## DARK AREA OPTIMIZATION (IDR)

### DYNAMIC RANGE

The contrast range of an object comprises all levels of brightness from the brightest to the darkest point in the image. All levels of brightness can be captured by the sensor, provided the contrast range of the object is lower than the dynamic range of the camera. In case of significant differences of brightness in the object (e.g. shootings of interior spaces with bright windows in the background, shootings with subject elements in shadow or directly lit by the sun, landscapes with dark areas and a very bright sky), the camera with its limited dynamic range will not be able to map the entire contrast range of the object. Information in 'edge areas' will be lost (under and overexposure).

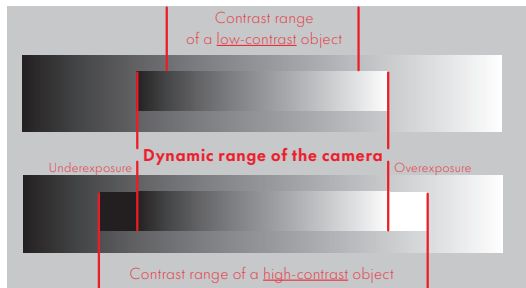

## iDR FUNCTION

The **iDR** (Intelligent Dynamic Range) function allows an optimization of the darker areas. Object details become much clearer.



You can specify beforehand if and to what extent you want to optimize darker areas (**High**, **Standard**, **Low**, **Off**). In the **Auto** setting, the camera will automatically select the right setting depending on the contrast range of the object.

In addition to that setting, the effect also depends on the exposure settings. The function will have the strongest effect in combination with low ISO values and fast shutter speeds. The effect is less pronounced with higher ISO values and/or slower shutter speeds.

Factory setting: **Auto**

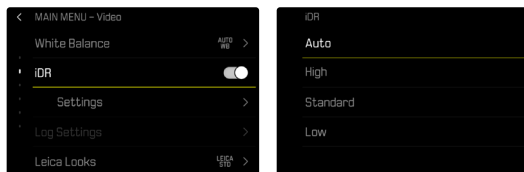

- Select **iDR** in the main menu
- Activate the function
- Select **Settings**
- Select the desired setting (**Auto**, **High**, **Standard**, **Low**)

### Notes

- The optimization of darker areas will slightly reduce differentiation in very bright areas.
- The **iDR** function is not available when **Video Game** is in use.

# DATA MANAGEMENT

## FORMATTING A MEMORY CARD

Memory cards that have already been in use with this camera will usually not require formatting. An unformatted memory card that is inserted into the camera for the first time must be formatted. We recommend formatting memory cards from time to time, because residual data traces (data pertaining to individual shots) may reduce the card's memory capacity.

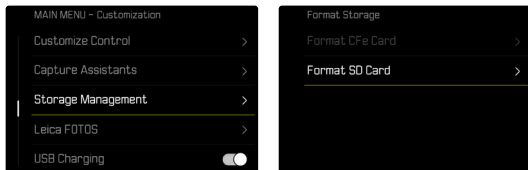

- Select **Storage Management** in the main menu
- Select **Format Storage**
- Select **Format SD Card**
- Confirm the selection
  - The status LED will flash during the process.

## Notes

- Never switch off the camera while data transfer is in progress.
- All data stored on the memory card will be lost during formatting. Formatting will not be prevented by a deletion protection set for individual shots.
- All images should therefore be regularly transferred to a safe mass storage medium, e.g. the hard disk of a computer.
- A simple formatting process will initially not irretrievably destroy existing data on the card. Only the directory will be deleted, which means the data will no longer be directly accessible. Data access can be restored with appropriate software. Only data that is overwritten when new data is saved will actually be irretrievable.
- A memory card should be formatted again in the camera if it was formatted in another device, e.g. a computer.
- Contact your retailer or Leica Customer Care for assistance if the memory card cannot be formatted/overwritten (see p. 244).

## DATA STRUCTURE

### FOLDER STRUCTURE

The files (= shots) on the memory cards are saved in automatically generated folders. The first three characters signify the folder number (numerals), the last five the folder name (letters). The first folder is assigned the name "100LEICA", the second "101LEICA". A folder will always be created with the next available number; you can have max. 999 folders.

### FILE STRUCTURE

The file names in these folders consist of eleven characters. In the factory settings, the first file is named "L1000001.XXX", the second "L1000002.XXX", etc. The first letter can be selected, the "L" from the factory settings denotes the camera brand. The first three characters signify the folder number (numerals). The next four digits denote the sequential file number. Once file number 9999 is reached, then a new folder will be automatically created, in which the file numbering begins at 0001 again. The last three places after the dot denote the file format (DNG or JPG).

### Notes

- When using memory cards that were not formatted with this camera, the file numbering will begin with 0001 again. Should the memory card already contain a file with a higher number, then numbering will be continued from that number.
- A relevant message will be displayed on the LCD panel once folder number 999 and file number 9999 are reached, and all numbering must be reset.
- Format the memory card and reset the frame number right after to reset the folder number to 100.

## EDIT FILE NAMES

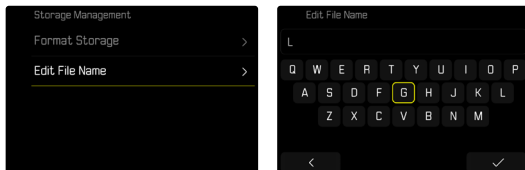

- Select **Storage Management** in the main menu
- Select **Edit File Name**
  - A keyboard submenu is displayed.
  - The input line contains the factory setting “L” as the first letter of the file name. Only this letter can be changed.
- Enter a letter of your choice
- Confirm

### Notes

- The change to a file name applies to all subsequent shots or until a new change is made. The sequential number will not be affected; but it will be reset when a new folder is created.
- During a reset to factory settings, the first letter will always be reset to “L”.
- Lower case letters are unavailable.

## CREATING A NEW FOLDER

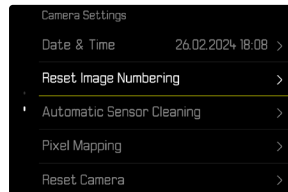

- Select **Camera Settings** in the main menu
- Select **Reset Image Numbering**
  - A relevant prompt is displayed.
- Confirm the creation of a new folder (**Yes**) or cancel the new folder (**No**)

### Note

- The name part (first letter) of a new folder created this way remains unchanged. The file numbers in that folder will start again at 0001.

## LOGGING THE SHOOTING LOCATION (ONLY IN CONNECTION WITH THE LEICA FOTOS APP)

Location information can be sourced from a mobile device in connection with the Leica FOTOS app. Current location information will then be written to the Exif data of the images (geotagging).



- Activating GPS functions on a mobile device
- Activate Leica FOTOS and connect to the camera (see chapter “Leica FOTOS”)
- Activate geotagging for this camera in Leica FOTOS

### Notes

- The use of GPS and associated technologies may be restricted in some countries or regions. Violations will be prosecuted by local authorities. You should therefore contact your travel agent or the embassy of your destination country for relevant information beforehand.
- It will take a few seconds for the Bluetooth connection to establish. The configured shutdown time should be considered when choosing a delay time if shutdown is enabled in the camera.

## GEOTAGGING STATUS

The status of the current location information is displayed in the Control Center.

	The location information is current (most recent geolocation max. 15 mins prior).
	The location information is not necessarily current anymore (most recent geolocation max. 12 h prior).
	The available location information is outdated (most recent geolocation more than 12 h in the past). No location data will be written to Exif data.
No icon	Geotagging is deactivated.

Location information will be continuously updated as long as the camera is connected to Leica FOTOS. The Bluetooth function of the camera and the mobile device must therefore remain enabled to ensure latest information. It is, however, not necessary for the app to be running in the foreground.

## DATA TRANSFER

Data can be conveniently transferred to mobile devices via Leica FOTOS. Alternatively, a card reader or USB cable can be used for the transfer.

### VIA LEICA FOTOS APP

→ See chapter “Leica FOTOS”

### VIA USB CABLE OR “LEICA FOTOS CABLE”

The camera supports multiple data transfer options. A transfer mode can be permanently selected or chosen every time a connection is established.

Factory setting: **Select on Connection**

→ Select **USB Settings** in the main menu

→ Select **USB Mode**

→ Select the desired setting

(**Mass Storage**, **PTP**, **Apple MFi**, **Select on Connection**)

- **Apple MFi** is used for the communication with iOS devices (iPhone and iPad)
- **PTP** allows a data transfer to computers using MacOS or Windows with PTP-capable programs, as well as tethering to Capture One Pro and Lightroom Classic
- Die setting **Select on Connection** will automatically propose a connection method depending on the type of cable connection.

## Notes

- We recommend using a card reader for the transfer of large files.
- The USB connection must not be interrupted while data is being transferred, as the computer or the camera could otherwise “crash” and irreparable damage could occur on the memory card.
- The camera must not be turned off or automatically shut itself down due to a lack of battery power while data is being transferred, as this can cause the computer to crash. For the same reason, the battery must never be removed from the camera while the connection is active.

# PRACTICAL DEFAULT SETTINGS

## TOUCH AF

Touch AF allows a direct placement of the AF frame.  
Factory setting: **Touch AF**

- Select **Focusing** in the main menu
- Select **Touch AF**

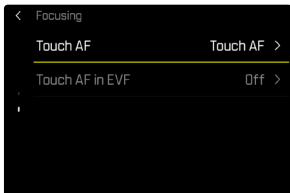

- Select **Touch AF**

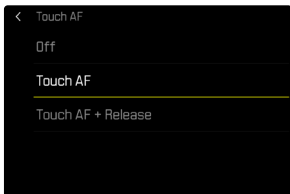

## Positioning the AF frame

→ Tap the LCD panel in the desired position

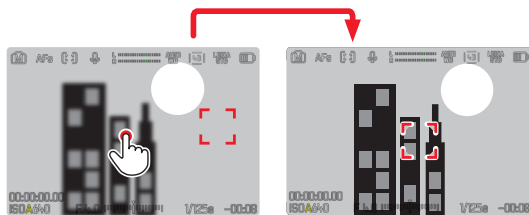

## Moving the focus frame back to the center of the screen

→ Double-tap the LCD panel

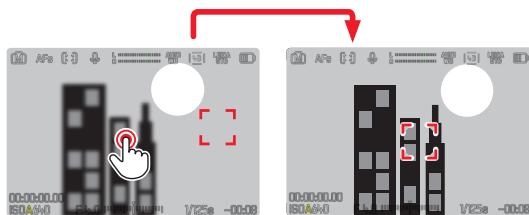

## Notes

- This function is available with all AF metering methods except **Multi-Field**.
- If the metering method **Tracking** is selected, the focus frame will remain at the selected position and auto-focus commences when the shutter button is tapped. For all other AF metering methods, focusing occurs automatically.
- The position of the AF frame can only be reset with a double-tap, even if the setting is **Off**.

## TOUCH AF + SHUTTER BUTTON

The combination **Touch AF + Release** allows a direct placement of the AF frame for immediate recording.

- Select **Focusing** in the main menu
- Select **Touch AF**
- Select **Touch AF + Release**
- Tap the LCD panel in the desired position

### Note

- The AF frame cannot be reset as usual via a double tap if **Touch AF + Release** is activated.

## TOUCH AF IN EVF MODE

Touch AF is deactivated by default when EVF is in use to prevent any inadvertent altering of the AF frame. AF Quick Setting (see p.176) continues to be accessible. This function can also be disabled if that is not wanted (e.g. when focusing with the left eye).

Factory setting: **Off**

- Select **Focusing** in the main menu
  - Select **Touch AF in EVF**
  - Select the desired setting  
(**On**, **AF Quick Setting only**, **Off**)
- **On**
    - Positioning the AF frame (tap)
    - Accessing the AF Quick Setting (tap and hold)
  - **AF Quick Setting only**
    - Accessing the AF Quick Setting (tap and hold)
  - **Off**

## AUDIO OUTPUT

### HDMI OUTPUT WITH/WITHOUT SOUND

HDMI output is available with or without audio.

Factory setting: **On**

- Select **HDMI with Audio** in the main menu
- Select the desired setting  
(**On**, **Off**)

### Note

- An output with audio may result in some negligible delays. We recommend the setting **Off** to avoid this effect (if, for example HDMI Live View is required for a recording with an external recorder).

## AUXILIARY DISPLAYS

You can select a number of other displays in addition to the standard information contained in the header and footer to adapt the screen image to your needs. The following functions are available:

- Grid (only shooting mode, see p.164)
- Focus Peaking (see p.165)
- Zebra (see p.164)
- Level Gauge (only shooting mode, see p.166)
- Histogram (see p.167)
- Framelines (see p.167)

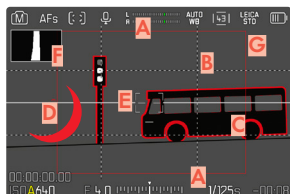

- A** Info Bars (= header and footer line)
- B** Grid lines
- C** Focus peaking
- D** Zebra
- E** Level gauge
- F** Histogram
- G** Framelines

- Select **Capture Assistants** in the main menu
- Select the desired function
- Select **On/Off**

## INFO PROFILES

Up to 4 independent profiles can be used for video mode. The desired function can be selected and adjusted individually for each profile. During operation, the switch between info profiles is done via direct access. In factory settings, that will be center button. It allows quick switches between various views.

Info Profiles will be configured and saved individually for Photo and Video mode.

Für Info Profiles in Photo mode see p.76.

The following profiles are predefined in the factory settings:

Profile	Factory Settings
1	Info bars only (Top / Bottom)
2	Full screen view (all auxiliary displays Off)
3	Info Bars (Top / Bottom + Right), Zebra, Focus Peaking, Histogram
4	Info Bars (Top / Bottom + Right), Grids, Zebra, Level Gauge

## CHANGING THE INFO PROFILES

- Press the function button with the **Toggle Info Levels** assignment
  - In factory settings, that will be center button.

### Note

- The same info profiles are available in playback mode as in shooting mode. The actual info profile currently in use, however, is saved separately.

## Briefly showing/hiding information

- Tap and hold the shutter button
  - (Only) the exposure information and currently active auxiliary functions will be visible.

## DEACTIVATING INDIVIDUAL INFO PROFILES

You can limit the number of info profiles by activating/deactivating individual profiles. At least one profile must always be active, but that can be an “empty” profile.

- Select **Capture Assistants** in the main menu
- Select a profile
- Select **On**

## CUSTOMIZING THE INFO PROFILES

- Select **Capture Assistants** in the main menu
- Select a profile
- Select **Settings**
- Select the desired function
- Select the desired setting

Function	Available settings
Info Bars	Top / Bottom (On, Dark Background, Off) Right (On, Dark Background, Off)
Grids	3 x 3, 6 x 4, Off
Zebra	On, Off
Focus Peaking	On, Off Color (Red, Blue, Green, White) & Sensitivity (Low, Medium, High): Settings apply for all info profiles
Level Gauge	On, Off
Histogram	On, Off
Framelines	4:3, 5:3, 37:20

### Note

- It is advisable to reserve one info profile as “empty”, in which all functions are set to **Off**. It allows you to temporarily hide all displays. In effect, you get an unobstructed view of the full screen image.

## SHOW AVAILABLE

### INFO BARS

The header and footer lines show the currently active settings and exposure values. See chapter “Displays” for a full list of the various displays (see p. 22).



### QUICK START BAR

The Quick Start bar on the right offers access to the profile settings.

## GRID LINES

The grids divide the image frame into multiple fields. They facilitate pictorial composition and an exact camera orientation.

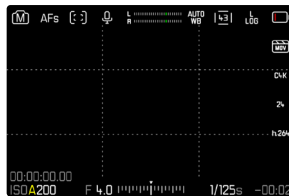

- Select **Capture Assistants** in the main menu
- Select **Grids**
- Select **On/Off**

## ZEBRA

The Zebra display marks very bright image areas. This function is a very easy and exact tool for checking the correct exposure setting. Overexposed areas will appear white with moving black stripes.



- Select **Capture Assistants** in the main menu
- Select **Zebra**
- Select **On/Off**

## FOCUS PEAKING

This assist function highlights the edges of in focus subject elements in color. The color can be user-specified. The sensitivity can be additionally adjusted.

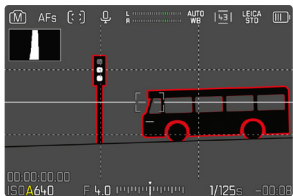

## HIGHLIGHT COLOR

Factory setting: **Red**

- Select **Capture Assistants** in the main menu
- Select the desired Info profile
- Select **Focus Peaking**
- Choose the desired color in the menu item **Settings**  
(**Off**, **Red**, **Green**, **Blue**, **White**)

## SENSITIVITY

Factory setting: **Medium**

- Select **Capture Assistants** in the main menu
- Select the desired Info profile
- Select **Focus Peaking**
- Choose the desired sensitivity in the menu item **Settings**  
(**Low**, **Medium**, **High**)

### Note

- Focus peaking is based on subject contrast, i.e. differences between light and dark. As a result, high contrast subject elements could be marked, even if they are not completely in focus.

## LEVEL GAUGE

The integrated sensors of the camera show its orientation. These indicators ensure exact camera orientation along the longitudinal and transverse axes of critical objects, e.g. architecture.

Deviations in relation to the longitudinal axis (i.e. when the camera is tilted up or down in the direction of view) are indicated by a short line in the center of the image (1).

Deviations in relation to the transverse axis (when the camera is tilted to the left or right) are indicated by two long lines to the left and right of the image center (2).

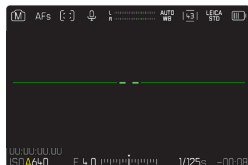

- Select **Capture Assistants** in the main menu
- Select **Level Gauge**
- Select **On/Off**

### Note

- The camera will switch the aspect of the level gauge autonomously for shoots in vertical format.

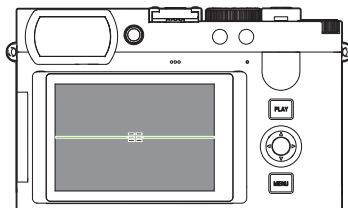

Correct alignment

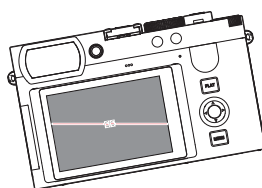

Tilted laterally to the left

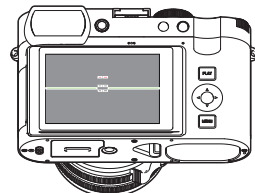

Tilted downward in the direction of view

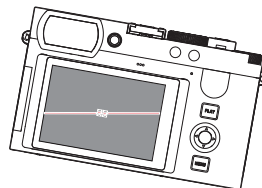

Tilted laterally to the right

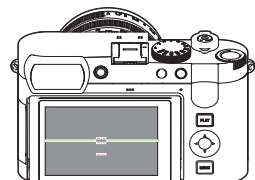

Tilted upward in the direction of view

## HISTOGRAM

Histogram represents the brightness distribution in the image. The horizontal axis shows the graduated values from black (left) through gray to white (right). The vertical axis corresponds to the number of pixels at each brightness level.

This type of rendering allows an additional quick and easy assessment of the exposure setting.

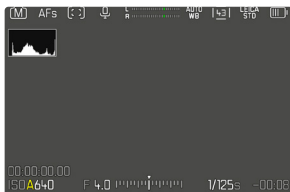

- Select **Capture Assistants** in the main menu
- Select **Histogram**
- Select **On/Off**

### Notes

- The histogram is always based on the brightness displayed; depending on the settings used, it may not represent the final exposure.
- In shooting mode, the histogram should be regarded as a “trend indicator”.

## FRAMELINES

The actually recorded aspect ratio depends on the set resolution. It is possible, however, to have colored auxiliary lines displayed to show other aspect ratios (e.g. 4:3). No auxiliary lines are displayed in factory settings.



- Select **Capture Assistants** in the main menu
- Select a profile
- Select **Setting**
- Select **FrameLines**
- Select the desired setting  
(4:3, 5:3, 37:20)

### Notes

- The format limits of a wider aspect ratio (than that of the recorded video) are indicated by horizontal green lines, those of a narrower one by vertical red lines.
- The auxiliary lines are labeled with the relevant aspect ratio.

## TEMPORARY ACTIVATION/DEACTIVATION OF INDIVIDUAL FUNCTIONS

The following assist functions can be activated/deactivated temporarily:

- Focus peaking
  - Zebra
- Assigning the desired assist function to a function button (see p. 54)
- Press the corresponding function button
- The status of the assist function toggles On/Off.
  - A relevant indicator appears in the screen image.

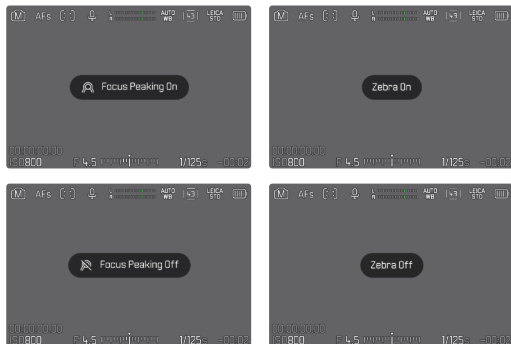

The temporary setting is reset when the camera is switched off.

## MF ASSIST FUNCTIONS

### ACOUSTIC AF CONFIRMATION

You can set an acoustic confirmation signal for successful focus metering in AF mode.

Factory setting: **Off**

- Select **Camera Settings** in the main menu
- Select **Acoustic Signal**
- Select **AF Confirmation**
- Select **On**
- Select **Volume**
- Select **Low/High**

#### Note

- The signal only appears during the focusing for a recording, not during recording.

## RECORDING VIDEO

The settings described in this chapter only apply for video operations. They are therefore part of the video menu and must always be accessed and configured from within video mode (see chapter “Camera operation” in the section “Menu Control”). Any menu items of the same name in the photo menu are not affected.

### Notes

- You can record up to 29 minutes of uninterrupted video.
- Some menu items are unavailable in Video mode. The text in the relevant line is displayed in gray to signify the existence of a submenu.
- Since only part of the sensor area is used in some video recording formats, the effective focal length increases. As a result, the image sections become slightly smaller. This effect depends on the selected video format.
- The screen image of video recordings with the Leica Q3 43 appears with corresponding frame depending on the selected resolution and aspect ratio.
- The automatic LCD panel and EVF shutdown will also deactivate the AF system (see p. 59). We therefore recommend the **Off** setting if autofocus is to be used in HDMI recordings.

## START/EXIT VIDEO MODE

The camera will always be in Photo mode at initial activation or after a reset to factory settings. There are two methods for toggling between Photo and Video mode:

### Using touch control

Variant 1

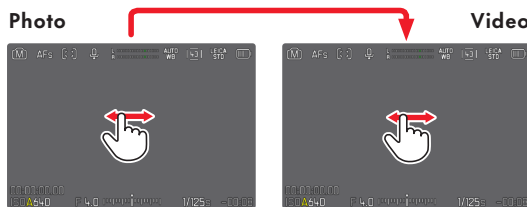

Variant 2

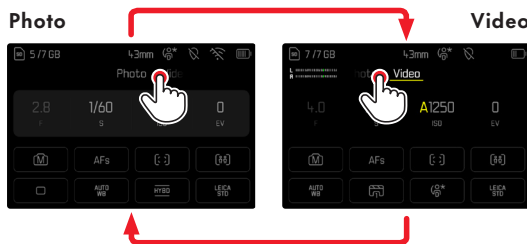

- The color of the Control Center changes accordingly.

### Using button control

- Press the function button with the function assignment **Photo - Video**
  - In the factory setting, that will be the FN Button 2 **(14)**.

### Note

- The camera switches to the most recently set photo or video mode.

## START/END VIDEO RECORDING



- Press the shutter button
  - Video recording begins.
  - The recording frame lights up red.
  - Recording time is running.
  - The Status LED flashes.
- Press the shutter button again
  - Video recording ends.

### Notes

- Basic video settings (see p. 142) and **Digital Zoom** (see p. 191) must be configured before recording.
- Access to menu functions (including direct access) is limited during video recording.

## DISPLAY AND OPERATION VIA USB-PTP USING EXTERNAL ACCESSORY (LIKE GIMBALS)

Leica Q3 43 allows connecting an optional Gimbal like DJI Ronin RS2 via USB-PTP. The Gimbal supports blur-free recordings.

- Select **USB Settings** in the main menu
- Select **USB Mode**
- Select **PTP** or **Select on Connection**
- Connecting the Gimbal to the camera (see Gimbal operating instructions)

Once the PTP connection is established, the camera can also be triggered via the shutter button on the Gimbal. Many Gimbal models allow controlling the focus function of the camera, provided it is in MF mode.

### Note

- The camera screen will switch off for technical reasons if external devices connected to the USB or HDMI output are operated simultaneously.

## FOCUSING

Your Leica Q3 43 allows automatic as well as manual focusing. There are 3 operating modes and 4 metering methods available for automatic focusing.

### TAKING VIDEOS WITH AF

Focusing is done as needed when **AFs** is in use. The area in the AF frame will be focused continuously if **AFc** is in use.

- Press and hold the AF/MF release button
- Turn the focus ring to the **AF** position
- Start video recording
- Controlling the autofocus (see p. 172)

### TAKING VIDEOS WITH MF

Focusing is done manually via the focus ring.

- Press and hold the AF/MF release button
- Turn the focus ring away from the **AF** position
- Use the focus ring to manually focus on the object

## AUTOFOCUS MODES

The following AF modes are available: **AFs**, **AFc** and **Intelligent AF**. The currently selected AF mode is shown in the header line.

Factory setting: **Intelligent AF**

- Select **Focusing** in the main menu
- Select **Focus Mode**
- Select the desired setting (**Intelligent AF**, **AFs**, **AFc**)

### INTELLIGENT AF

In this mode, the camera will refocus as soon as it registers a color or brightness/contrast change in the entire image section. The focus field depends on the autofocus metering method selected.

#### AFs (single)

A meaningful option if the focus setting should remain constant for an extended period of time. Allows greater control over focusing and helps to avoid incorrect focusing.

#### AFc (continuous)

Suitable for objects in motion. Focusing is continuously adjusted to the object in the AF frame.

Facilitates an intuitive focus control, specifically in conjunction with Touch AF.

## CONTROLLING THE AUTOFOCUS

### TOUCH AF

During video recordings, Touch AF facilitates a more intuitive focus control, even if the main object moves outside the center of the frame. See p. 160 for additional information.

- Tap the LCD panel in the desired position
  - Focusing is done after the touch.

### CONTINUOUS FOCUSING

The area in the AF frame will be focused continuously if **AFc** and **iAF** are in use. That occurs automatically, without having to tap and hold the shutter button. This type of focusing is significantly smoother than focusing accessed via the shutter button, as jumps are avoided. Quick focusing can, however, be forced via the shutter button or Touch AF.

## AUTOFOCUS METERING METHODS

The AF mode offers various metering methods for focusing. A successful focus setting is identified by a green frame, an unsuccessful one is shown in red.

Factory setting: **Field / Spot**

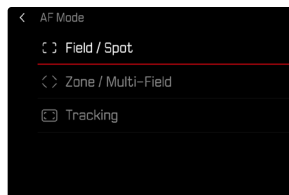

- Select **Focusing** in the main menu
- Select **AF Mode**
- Select the desired setting  
(**Field / Spot**, **Zone / Multi-Field**, **Tracking**)

### Notes

- AF focusing can be unsuccessful:
  - if the distance to the object is too great (macro mode) or too small
  - if the object is not sufficiently illuminated
- The size of the focus frame can be set for Field/Spot Metering and for Zone/Multi-Field Metering. See p. 176 for more information.

## FIELD/SPOT METERING

In this mode, only the subject elements within the AF frame will be captured. The focus area is marked by a small frame. The measuring range permits selective metering. The AF frame can be repositioned (see p. 177).

## ZONE/MULTI-FIELD METERING

In this mode, sections of the object are captured automatically using a continuous group of multiple focus fields.

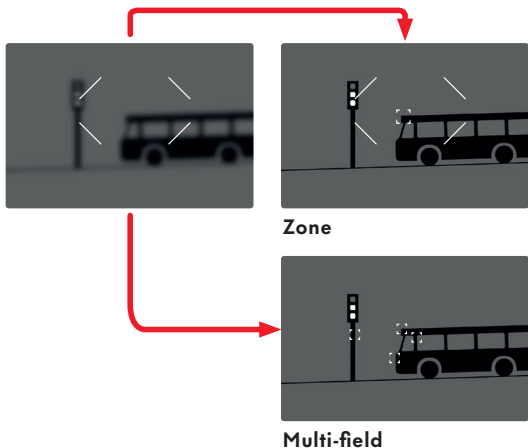

Once the setting has been made, the focus frames are displayed where object sections are displayed in focus.

## TRACKING

This mode is useful for the capture of moving objects. The focus on the object in the focus frame is continuously adjusted, once it is detected.

→ Aim the focus frame at the desired object  
(by panning the camera shifting the focus frame)

→ Tap and hold the shutter button

or

→ Press the function button  
(provided it was assigned the function **AF-L** or **AF-L**  
**+ AE-L**, see p. 54)

- The camera focuses on the object.

→ Pan the camera to the desired cropped section

- The focus frame “tracks” the saved object and focus is continuously adjusted.

### Note

- This metering method focuses continuously, even if the AF mode **AFs** was set.
- The type of the tracked object depends on the setting under the menu item **AF Detection**. When **AF Detection** is set to people or animals, the system will search for, recognize, and track only people or animals.
- **AF Detection** must be set to **Off** if objects should be tracked instead.

## AF DETECTION AUTOMATIC SUBJECT RECOGNITION

The camera automatically detects various subjects – including people and animals – and focuses specifically on eyes, faces, or bodies. The main subject remains reliably in focus, even if there is movement or a brief obstruction. Automatic subject recognition provides precise and continuous focus tracking in every shooting situation.

Setting: **Human (Eye/Face/Body)**

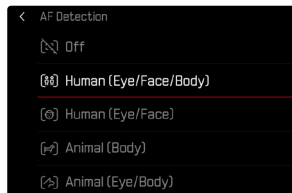

- Select **Focusing** in the main menu
- Select **AF Detection**
- Select the desired setting  
(**Off**, **Human (Eye/Face/Body)**, **Human (Eye/Face)**,  
**Animal (Body)**, **Animal (Eye/Body)**)

### Note

- Where rapid changes to AF detection are necessary, **AF Detection** can be assigned to a function button (see p. 54).

## EYE/FACE/BODY DETECTION

Setting: **Human (Eye/Face/Body)**

In addition to biometric face patterns, the camera also detects body patterns and uses these for focusing during Eye/Face/Body Detection. Tracking will therefore continue, once a person is detected and measured, even if the face may not be in view at some point. This feature prevents inadvertent “jumps” to other faces if several persons are in the frame.

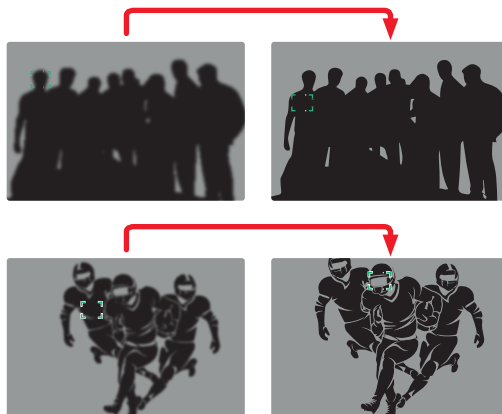

## FACE DETECTION

Setting: **Human (Eye/Face)**

In face detection, biometric face patterns are detected and used for automatic focusing. An appropriate face is tracked continuously. When face detection detects an eye, the focus will be on that eye. Should more than one eye be detected, then the user can choose the eye to focus on. The currently selected eye will be highlighted. Additionally, the desired face can be easily selected if there are several faces in the frame.

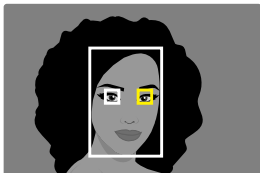

### toggling between faces and/or eyes

→ Press the directional pad in the relevant direction

## ANIMAL DETECTION

Settings: **Animal (Body)** or **Animal (Eye/Body)**

In Animal Detection mode, several common pet species are recognized and brought into focus.

## AF DETECTION IN COMBINATION WITH ZONE/MULTI-FIELD METERING

With Zone / Multi-Field metering, the desired focus point can be selected from all subjects detected within the measurement area.

- Press the directional pad in the relevant direction
- A white outline indicates recognized objects, while a yellow outline highlights the selected object.



## AF QUICK SETTING

The AF Quick Setting allows quick changes to the focus frame size in some AF metering methods.

The screen image will remain visible continuously while settings are being adjusted.

### ACCESSING AF QUICK SETTING

- Tap and hold the LCD panel
  - All auxiliary displays are hidden.
  - White triangles appear at two corners of the focus frame when the metering method **Field / Spot** or **Zone / Multi-Field** is set as the AF Mode.

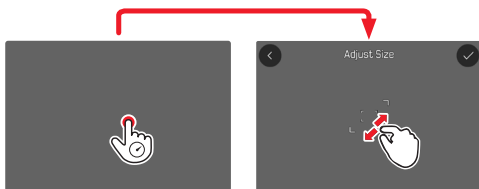

### ADJUSTING THE AF FRAME SIZE

(only **Field / Spot** or **Zone / Multi-Field**)

- Turn the thumbwheel
- or
- Two-finger pinch/spread
  - The size of the AF frame is adjustable in 3 increments.
- or
- Press the function button
  - The **AF Frame Size** function must be assigned to one of the function buttons to use this feature (see p. 54).

## MF ASSIST FUNCTIONS

### ENLARGEMENT IN AF MODE

You can access the enlargement function independent of focusing for a better assessment of the settings.

The function **Magnification** must be assigned to one of the function buttons to use this feature (see p. 54).

### Assigning a function to one of the function buttons

- See p. 54

### Accessing the enlargement function

- Press the function button
  - An enlarged image section appears. The position of the enlargement depends on the position of the AF frame.
  - The rectangle within the frame at the top right represents the current magnification, as well as its position in the displayed cropped section.



## Adjusting the enlargement function

- Turn the thumbwheel
  - The image section toggles between magnification factors.

## Changing the position of the enlarged section

- Press the directional pad in the relevant direction

## Exiting the enlargement function

- Tap the shutter button

or

- Press the function button again

### Notes

- The enlargement function remains active until it is exited.
- The most recently magnification function will still be active the next time the feature is accessed.
- This function is unavailable while recording.

## AF ASSIST LAMP

The AF assist lamp is not active in video mode.

## ACOUSTIC AF CONFIRMATION

You can set an acoustic confirmation signal for successful focus metering in AF mode (see p. 63).

### Note

- This function is unavailable while recording.

## SHIFTING THE AF FRAME

All AF metering methods permit shifting the AF frame before focusing.

- Press the directional pad in the relevant direction

or

- Tap the LCD panel in the desired position  
(While Touch AF is activated)

### Notes

- The focus frame will remain at the most recently used position for this AF metering method even if the user changes the AF metering method or the camera is switched off.
- Focus areas will be interlinked if the exposure metering method **Spot** is combined with the AF metering methods (**AF Mode**) **Field / Spot** or **Zone / Multi-Field**. Exposure metering will then occur at the point specified by the AF frame, even if it is moved.
- The focus area can be centered. The function **Toggle Focus Point** must be assigned to one of the function buttons (see p. 54).

## MANUAL FOCUSING (MF)

Manual focusing offers more control and is less prone to incorrect settings than the AF modes.

- Move the focus ring out of the **AF** position (press and hold the AF/MF lock release)

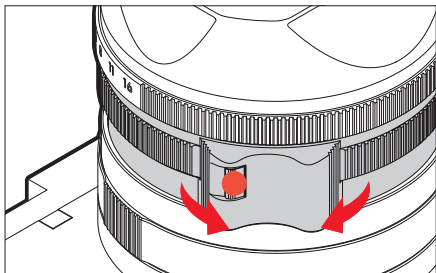

- Start video recording
- Turn the focus ring to select the desired focusing

## MF ASSIST FUNCTIONS

The following assist functions are available in MF mode.

### FOCUS PEAKING

This assist function highlights the edges of in focus subject elements in color. The color can be user-specified. The sensitivity can be additionally adjusted. See p. 165 for settings.

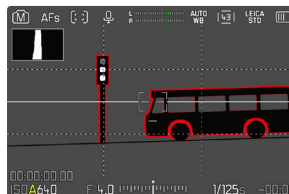

- Select **Capture Assistants** in the main menu
- Select **Settings**
- Select **Focus Peaking**
- Select the desired setting (**Off**, **Red**, **Green**, **Blue**, **White**)
- Specify an image section
- Turn the focus ring to mark the desired subject elements

### Note

- Focus peaking is based on subject contrast, i.e. differences between light and dark. As a result, high contrast subject elements could be marked, even if they are not completely in focus.

## ENLARGEMENT IN MF MODE

The larger the details of the object are shown, the better you can assess their sharpness and the more accurately you can focus.

This function can be automatically activated during manual focusing or can be accessed independently.

### ACCESS VIA THE FOCUS RING

Turning the focus ring will automatically enlarge a image section.

- Select **Focusing** in the main menu
- Select **Auto Magnification**
- Select **On**
- Turn the focus ring
  - An enlarged image section appears. The position of the enlargement depends on the position of the AF frame.
  - The rectangle within the frame at the top right represents the current magnification, as well as its position in the displayed cropped section.

### Adjusting the enlargement function

- Press the center button
  - The image section toggles between magnification factors.

### Changing the position of the enlarged section

- Press the directional pad in the relevant direction

### Exiting the enlargement function

- Tap the shutter button

#### Notes

- The magnification will automatically return to normal viewing size about 5 s after the last movement of the focus ring.
- The most recently magnification function will still be active the next time the feature is accessed.

## ACCESS VIA THE FUNCTION BUTTON

You can access the enlargement function independent of focusing for a better assessment of the settings.

The function **Magnification** must be assigned to one of the function buttons to use this feature (see p. 54). In factory settings, that will be center button.

### Accessing the enlargement function

- Press the center button
  - An enlarged image section appears. The position of the enlargement depends on the position of the AF frame.
  - The rectangle within the frame at the top right represents the current magnification, as well as its position in the displayed cropped section.

### Adjusting the enlargement function

- Turn the thumbwheel
  - The image section toggles between magnification factors.

### Changing the position of the enlarged section

- Move the position of an enlarged cropped section by swiping

or

- Press the directional pad in the relevant direction

### Exiting the enlargement function

- Tap the shutter button

#### Notes

- The enlargement function remains active until it is exited.
- This function is unavailable while recording.

## MACRO FUNCTION

The working range for the focus setting can be switched quickly and easily from the standard focus range (30 cm to infinity) to the macro range (17 cm to 30 cm) using the macro ring. AF and MF mode are available in both ranges.

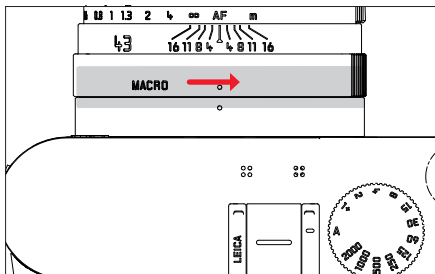

- Turn the macro ring until the alignment point is set to **MACRO**
  - The distance scales on the focus ring change when the focus ranges change.

## ISO SENSITIVITY

The ISO setting covers a range between ISO 50 and ISO 100 000, allowing you to adapt to the relevant situation as required.

There is more leeway for the use of preferred shutter-speed/aperture combinations when choosing an automatic ISO setting. You can set priorities within the scope of the automatic setting.

Factory setting: **Auto ISO**

## FIXED ISO VALUES

Values between ISO 50 and ISO 100 000 can be selected in 14 increments. Manual ISO settings are initially done in full EV steps, and from ISO 50,000 in 1/3 EV steps.

- Select **ISO** in the main menu
- Select the desired value

### Note

- When high ISO values are used or the video file is edited later, image noise, as well as vertical and horizontal stripes may become visible, particularly in larger, evenly lit areas of the object.

## AUTOMATIC SETTING

The camera automatically adjusts the sensitivity to ambient brightness and/or to the configured shutter-speed/aperture combination. In conjunction with aperture-priority mode, this function extends the range for automatic exposure control. The automatic setting of ISO sensitivity occurs in increments of 1/3 EV.



- Select **ISO Settings** in the main menu
- Select **ISO**
- Select **Auto ISO**

## LIMITING SETTING RANGES

A max. ISO value can be set, which will then limit the automatic setting range (**Max. ISO value**).

A max. exposure time can also optionally be configured. There are automatic settings and fixed max. shutter speeds **1/30**s and **1/2000**s available for that purpose.

### LIMITING ISO VALUES

All values from ISO 200 are available.

Factory setting: **6400**

- Select **ISO Settings** in the main menu
- Select **Auto ISO Settings**
- Select **Maximum ISO**
- Select the desired value

### LIMITING SHUTTER SPEED RANGES

Factory setting: **Auto**

- Select **ISO Settings** in the main menu
- Select **Auto ISO Settings**
- Select **Shutter Speed Limit**
- Select the desired value  
(**Auto**, **1/2000**, **1/1000**, **1/500**, **1/250**, **1/125**, **1/60**, **1/30**)

### Note

- When Auto ISO is active, the camera uses the dynamic adjustment function for the ISO value for the exposure setting. Depending on the exposure mode selected, the automatic ISO setting interacts with automatically controlled aperture and/or shutter speed settings.

## DYNAMIC ISO SETTING

The thumbwheel can be configured to allow manual ISO settings in real time (see p. 54). The settings will cycle through all values available in the **ISO** menu. That means that **Auto ISO** can also be selected.

## WHITE BALANCE

In white balance ensures neutral color rendering in any light. White Balance relies on the setting made in the camera, which light color is to be rendered as 'white'.

Four methods are available:

- automatic control
- fixed presets
- manual setting via metering
- direct setting of the color temperature

Factory setting: **Auto**

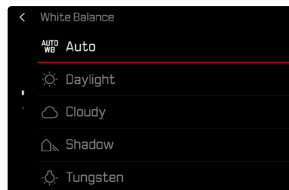

## AUTOMATIC CONTROL/FIXED SETTINGS

- **Auto**: for automatic control, which delivers neutral results in most situations
- Various fixed presets for most frequently encountered light sources:

Daylight	For outdoor shootings in sunlight
Cloudy	For outdoor shootings in cloudy conditions
Shadow	For outdoor shootings with the main subject in shadow
Tungsten	For indoor shootings with (predominantly) incandescent lamp light

- Select **White Balance** in the main menu
- Select the desired setting

## MANUAL SETTING VIA METERING

This metering variant captures all color hues in the metering field and uses these to calculate a mean gray value.

- Select **White Balance** in the main menu
- Select **Gray Card**
  - The following appears on the LCD panel:
    - the image based on automatic white balance
    - a frame in the center of the image

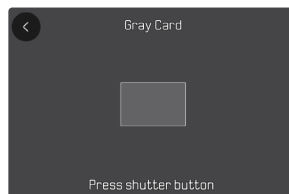

- Aim the metering field at a white or neutral gray area
  - The screen image changes dynamically in line with the reference area in the frame.

### Performing measurement

- Shutter release
  - The measurement is taken.

### Cancelling measurements

- Press the center button

### Note

- A value configured using this method will remain unchanged (i.e. it will be used for all subsequent photographs) until new measurements are taken or one of the other white balance settings is selected.

## DIRECT SETTING OF THE COLOR TEMPERATURE

Values between 2000 and 11500 K (Kelvin) can be set directly. That gives you a very wide range, which covers virtually all color temperatures occurring in real life and within which you can adapt color rendering to any light color and your personal preferences with incredible detail.

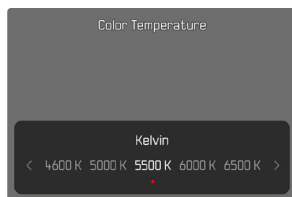

- Select **White Balance** in the main menu
- Select **Color Temperature**
- Select the desired value

## EXPOSURE

### EXPOSURE METERING METHODS

Factory setting: **Multi-Field**

- Select **Exposure Metering** in the main menu
- Select the desired metering method (**Spot**, **Center-Weighted**, **Highlight-Weighted**, **Multi-Field**)
  - The selected metering method is displayed in the header line of the screen image.

Spot metering allows a shifting of the focus point.

- Press the directional pad in the relevant direction

### Note

- The exposure information (ISO value, aperture, shutter speed and light balance with exposure compensation scale) will help to determine the settings required for correct exposure.

## SPOT

This metering method is concentrated exclusively on a small area in the center of the image. The metering fields are joined together when the exposure metering method **Spot** is combined with the AF metering methods **Spot** and **Field**. Exposure metering will then occur at the point specified by the AF frame, even if it is moved.

## CENTER-WEIGHTED

This method considers the entire image field. The subject elements captured in the center will, however, impact on the calculation of the exposure value more so than areas around the edges.

## MULTI-FIELD

This metering method is based on the detection of multiple values. These values are used in an algorithm to calculate an exposure value appropriate for a good rendering of the assumed main subject.

## HIGHLIGHT-WEIGHTED

This method considers the entire image field. The exposure value will, however, be adjusted to very bright subject elements. That prevents the overexposure of bright subject elements without having to measure them individually. This metering method is particularly useful for objects that are significantly more brightly lit than the rest of the frame (e.g. people in a spotlight), or that reflect the light significantly (e.g. white clothing).

Multi-field	Highlight-weighted
	
	
	

## EXPOSURE MODES

You can choose one of four video shooting modes:

- Program AE mode (**P**)
- Aperture-priority mode (**A**)
- Shutter-priority mode (**S**)
- Manual setting (**M**)

These four “classic” modes are accessed via a relevant setting of the shutter-speed dial and the aperture ring. A correct setting for the menu item **Scene Mode** (see p.186) is prerequisite for the use of **P**, **A**, **S** and **M**. The menu item **P-A-S-M** must be selected. Where the fully automated mode **AUTO** is selected instead, then that setting takes precedence over settings on the physical control elements. The shutter-speed dial and the aperture ring will in that case have no assigned function.

### Note

- The following applies for all exposure modes: the available shutter speeds for custom settings or those available for automatic settings depend on the selected frame rate (**Video Format / Resolution**, see p.142).

## SELECTING A MODE

The four operating modes are activated automatically via the following setting combinations:

	Setting via the shutter-speed dial	Setting via the aperture ring
<b>P</b>	<b>A</b>	<b>A</b>
<b>A</b>	<b>A</b>	manual setting (not <b>A</b> )
<b>S</b>	manual setting (not <b>A</b> )	<b>A</b>
<b>M</b>	manual setting (not <b>A</b> )	manual setting (not <b>A</b> )

- Select **Scene Mode** in the main menu
- Select **P-A-S-M**
- Set the shutter-speed dial to the relevant position
- Set the aperture ring to the relevant position

## FULLY AUTOMATIC EXPOSURE SETTING – P

### PROGRAM AE MODE – P

The exposure is controlled by an automatic shutter speed and aperture setting.

- Select **Scene Mode** in the main menu
- Select **P-A-S-M**
- Turn the shutter-speed dial to the **A** position
- Turn the aperture ring to the **A** position
- Set exposure compensation as needed
- Start video recording

### Note

- Automatic exposure control takes into account any fluctuations in brightness. Set the shutter speed manually if this is undesirable, e.g. for landscape recordings or panning.

## SEMI-AUTOMATIC EXPOSURE SETTING – A/S

### APERTURE-PRIORITY MODE- A

Aperture-priority mode sets the exposure automatically according to the manually selected aperture. It is therefore specifically suitable for video recordings in which the depth of field is a critical compositional element.

The range of the depth of field can be diminished with an accordingly small aperture value. This will set off the focused area against the unfocused background. Conversely, a greater aperture value will increase the range of the depth of field. Such a setting is advisable if the foreground and background should be rendered in sharp focus.

The selected aperture setting will be maintained for the duration of the recording.

- Select **Scene Mode** in the main menu
- Select **P-A-S-M**
- Turn the shutter-speed dial to the **A** position
- Set the desired aperture value
- Start video recording

## SHUTTER-PRIORITY MODE – S

Shutter-priority mode will set exposure automatically according to the manually selected shutter speed. The selected shutter speed will be maintained for the duration of the recording.

- Select **Scene Mode** in the main menu
- Select **P-A-S-M**
- Turn the aperture ring to the **A** position
- Set the desired shutter speed
  - using the shutter-speed dial: in full increments
  - using the thumbwheel: fine tuning in 1/3 increments
- Start video recording

### Note



- Alternatively, fine tuning can be done via the Control Center. Depending on the thumbwheel assignment, this may be the only option (see p. 54).

## MANUAL EXPOSURE SETTING – M

The following manual settings for shutter speed and aperture are a good choice:

- to maintain constant exposure settings between multiple recordings
- to maintain constant exposure settings while recording, specifically in conjunction with fixed ISO settings
- Select **Scene Mode** in the main menu
- Select **P-A-S-M**
- Set the desired exposure manually (using the shutter-speed dial and the aperture ring of the lens)
  - The exposure compensation is done using the scale of the light balance.
- Start video recording

Displays on the light balance:

	Correct exposure
	Underexposure or overexposure by the displayed value
	Under or overexposure by more than 3 EV

### Note

- The shutter-speed dial must be clicked to one of the engraved exposure shutter speeds.

## SETTING SHUTTER SPEEDS

The shutter speed is set in two steps.

1. using the shutter-speed dial: in full increments
2. using the thumbwheel: fine tuning in 1/3 increments (provided the **Shutter Speed** is assigned to the button, see p. 54)

Shutter-speed dial	Thumbwheel
All settings from <b>30</b> to <b>1000</b>	Fine tuning the shutter speed in 1/3 EV increments, max. $\pm 2/3$ EV
Set to <b>15, 8, 4, 2, +1</b>	Fine tuning is not available. The shutter speed is 1/25 s
Set to <b>2000</b>	Shorter shutter speeds than 1/2000 s (1/1250 s to 1/16000 s in 1/3 EV increments)

## EXAMPLES FOR SHUTTER SPEED FINE TUNING SETTINGS

- set shutter speed 1/125 s + move the thumbwheel one click to the right = 1/100 s
- set shutter speed 1/500 s + move the thumbwheel two clicks to the left = 1/800 s

### Notes

- Alternatively, fine tuning can be done via the Control Center. Depending on the thumbwheel assignment, this may be the only option (see p. 54).
- The max. available shutter speed is limited by the set frame rate (**Video Resolution**).

## EXPOSURE CONTROL

### EXPOSURE COMPENSATION

Exposure compensation values can be set in the range  $\pm 3$  EV in 1/3 EV increments (EV: Exposure Value).

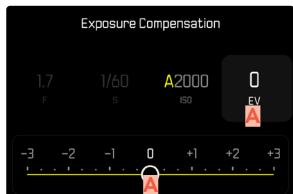

**A** Set compensation value (marks at 0 = Off)

#### Using thumbwheel control

- Select **Customize Control** in the main menu
- Select **Thumbwheel**
- Select **Manual**
- Select **Exposure Compensation**
- Set the desired value using the thumbwheel

#### Using menu control

- Select **Exposure Compensation** in the main menu
  - A scale appears as a submenu item on the LCD panel.
- Set the value on the scale
  - The set value is displayed above the scale.
  - While setting the value, you can see the effect on the screen image, which becomes darker or lighter.

#### **Note**

- The following applies for set compensation values, no matter how they were initially set: They remain effective until they are manually reset to **0**, even if the camera is switched off and on again in the meantime.

## SPECIAL SHOOTING MODES

### DIGITAL ZOOM

Several other cropped section sizes are available in addition to the APO-Summicon 43 f/2 ASPH. image sections. These are similar to the focal lengths 60 mm, 75 mm, 90 mm, 120 mm or 150 mm.

A frame appears around the image section on screen, indicating the final image size. The magnification level is displayed as an equivalent focal length, i.e. the system displays the focal length corresponding to the image section shown.

Factory setting: 43 mm (no Digital Zoom)

### PERMANENT SETTING

- Select **Digital Zoom** in the main menu
- Select the desired setting  
(60 mm, 75 mm, 90 mm, 120 mm, 150 mm)









### DIRECT ZOOM CHANGE

The zoom level can be switched quickly if the **Digital Zoom** function is assigned to a function button (see p. 54).

- Press the function button with the **Digital Zoom** assignment
  - In the factory setting, that will be the FN Button 1 **(F3)**.
  - A frame appears around the image section on screen, indicating the final image size.
  - The display cycles through the magnification factors each time the button is pressed.
  - The set level will remain until the next change.

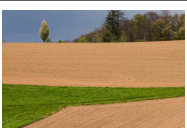
### Notes

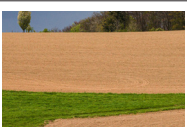
- The screen image is magnified to the selected image section during recording.
- The use of digital zoom may result in reduced image quality.

Digital Zoom	In shooting mode	In Playback mode
Digital Zoom 60 mm		
Digital Zoom 75 mm		
Digital Zoom 90 mm		
Digital Zoom 120 mm		
Digital Zoom 150 mm		

## LIMITING DIGITAL ZOOM LEVELS

The Digital Zoom levels available for selection can be limited as needed. That allows for quicker changes between desired Digital Zoom levels.

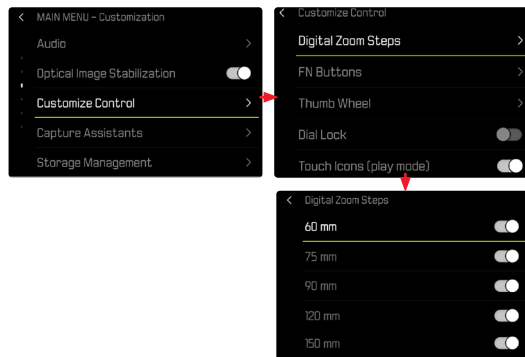

- Select **Customize Control** in the main menu
- Select **Digital Zoom Steps**
- Activating/Deactivating Digital Zoom levels (60 mm, 75 mm, 90 mm, 120 mm, 150 mm)

### Note

- These Digital Zoom limits will be saved individually for Photo and Video mode.

## FULLY AUTOMATIC VIDEO RECORDING

In fully automated video mode, exposure is controlled by the camera just like for recordings in automatic program mode (P). Additionally, all other exposure-relevant factors like ISO values and exposure metering are controlled automatically.

→ Select **Scene Mode** in the main menu

→ Select **AUTO**

### Notes

- The selected program will remain active until a different program is selected (even after the camera is switched off).
- The menu item Scene Mode will reset to **P-A-S-M** if the shooting mode is changed (Photo/Video).
- Some menu items will not be available.
- The shutter-speed dial and the aperture ring are without function.

## PLAYBACK MODE

Playback mode is used to display and manage the stored recordings. The switchover between shooting and playback mode, as well as most other actions can be completed using gesture or key control. Please see p. 41 for more information about the available gestures.

### Notes

- Recorded videos are not automatically rotated in playback mode to utilize the full screen area.
- It may not be possible to render files with this camera that were not recorded with this device.
- In some cases, the screen image may not have the expected quality, or the LCD panel will remain blank and only display the file name.
- You can toggle back from playback mode to shooting mode at any time by tapping the shutter button.
- Video recordings cannot be enlarged.

## CONTROL ELEMENTS IN PLAYBACK MODE

### CONTROL ELEMENTS ON THE CAMERA

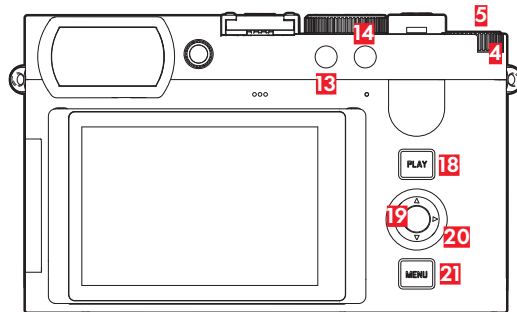

**4** Thumbwheel

**5** Thumbwheel button

**13** FN button 1

**14** FN button 2

**18** PLAY button

**19** Center button

**20** Directional pad

**21** MENU button

## DIRECT ACCESS IN PLAYBACK MODE

The function buttons can have individual assignments in playback mode as well.

In factory settings, the function buttons have the following assignments:

Button	Function
Thumbwheel button (5)	Mark shots (Rate / Unrate)
FN button (13)	EVF <> LCD
FN button (14)	Magnification
Center button (19)	Toggle Info Levels

The descriptions in the next few sections presume factory settings.

### Notes

- The assigned function is independent of the current display mode; the delete functions overview can therefore be accessed directly in full screen display mode.
- The assigned function is unavailable if the function button addresses an on-screen control element (e.g. in the "Delete" screen).

## CONTROL ELEMENTS ON THE LCD PANEL

On-screen control elements generally function by intuitively by touch. Many can also be selected by pressing one of the three buttons to the right of the LCD panel (**PLAY** button, center button, **MENU** button). A control element in the header is accompanied by an icon denoting the relevant button. A control element on the edge of the screen will be positioned directly next to the relevant button.

You have e.g. two options to select the Favorites icon ★:

- Tap on the Favorites icon directly
- press the relevant button  
Factory setting: thumbwheel button (5)

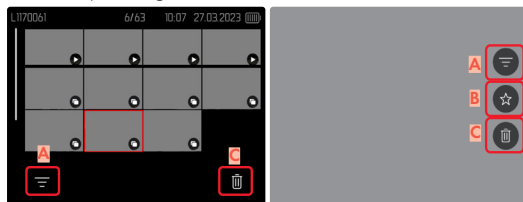

- A** Control element "Filter"
- B** Control element "Favorites"
- C** Control element "Delete"

## STARTING/EXITING PLAYBACK MODE

Using touch control

→ Swipe down

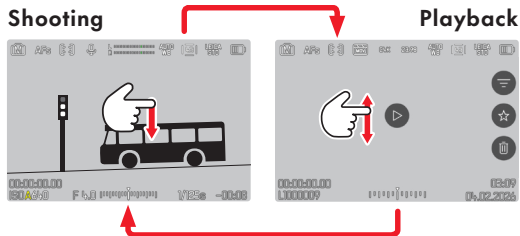

Using button control

→ Press the **PLAY** button

- The last video taken appears on the screen.
- The message **No valid video to play** appears if the inserted memory card does not contain any recording data.
- The **PLAY** button function differs, depending on the current camera setting

Initial situation	After pressing the <b>PLAY</b> button
Full screen display of a recording	Recording mode

## SELECTING/SCROLLING THROUGH RECORDINGS

The images are visually arranged in a horizontal reel. The sorting will be strictly chronological. When the end of an image series is reached, the display automatically jumps back to the first image in the series. All recordings can therefore be reached by scrolling either right or left.

### SINGLE

Using touch control

→ Swipe to the left or right

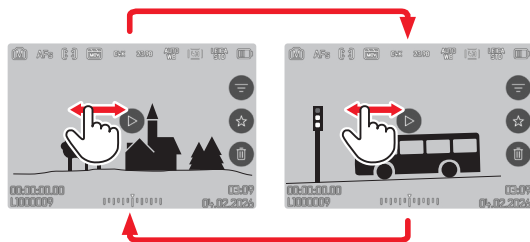

Using button control

→ Press the directional pad left/right

### CONTINUOUS

→ Swipe to the left or right and hold the finger on the edge of the screen

- The subsequent shots will move past continuously.



## INFO DISPLAYS IN PLAYBACK MODE

The same info profiles are available in playback mode as in shooting mode. The actual info profile currently in use, however, is saved separately. It is therefore possible to use an empty info profile completely without assist function icons in playback mode, without having to set them again when switching to shooting mode. The assist functions **Grids**, **Level Gauge** or **Framelines** are not available in playback mode.



Info Bars

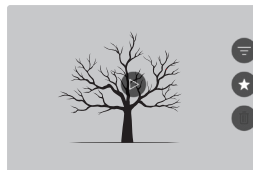

Empty info profile

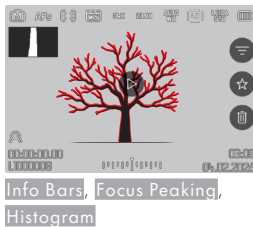

Info Bars, Focus Peaking,  
Histogram



Info Bars

### Switching between info profiles

The function **Toggle Info Levels** must be assigned to one of the function buttons to use this feature (see p. 54).

- Press and hold the assigned function button
  - The info bars appear (header and footer line always appear/disappear together in playback mode).
  - The displays for **Histogram** and **Clipping** will appear if these functions are activated.

## DISPLAYING MULTIPLE RECORDINGS AT ONCE

The camera offers an overview function in which several thumbnail images can be viewed on one screen, which makes it easier to find a specific image. Choose to display 9 or 16 thumbnails for your overview.

### OVERVIEW

Using touch control

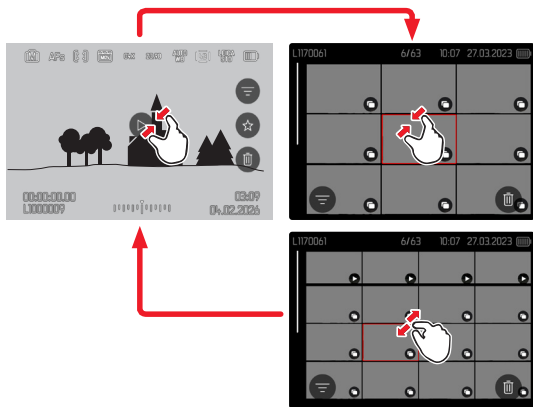

- Two-finger pinch
  - The display toggles between 9 or 16 thumbnails.

### Viewing other recording

→ Swipe up or down

Using button control

- Turn the thumbwheel to the left
  - An overview with 9 thumbnails is displayed.  
Another turn on the dial increases the number of displayed thumbnails to 16.

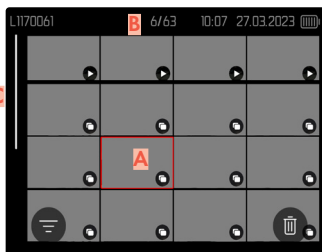
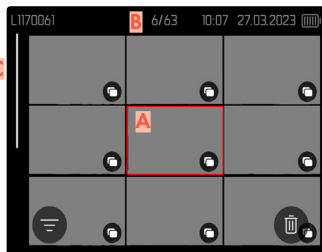

- A** Currently selected recording
- B** Number of the currently selected recordings
- C** Scrollbar

The currently viewed recording is framed in red and can be selected for a closer look.

## Navigating between recordings

- Press the directional pad in the relevant direction
- or
- Turn the thumbwheel

## Displaying the recording in full size

### Using touch control

- Two-finger spread
- or
- Tap the desired recording

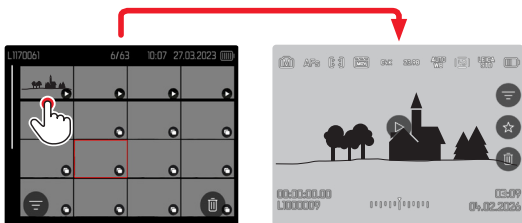

### Using button control

- Turn the thumbwheel to the right
- or
- Press directional pad, thumbwheel or **PLAY** button

## TAGGING/RATING OF RECORDINGS

Recordings can be marked as favorites to find them quicker or to simplify the later deletion of multiple recordings. Tagging can be done in regular view mode or in the overviews.

### Tagging a recording

- Press the thumbwheel button
- or

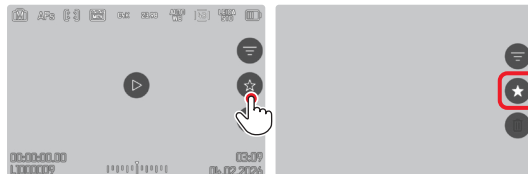

- Tap the ★ icon
  - The ★ icon is highlighted.
  - The icon will appear in the header on the far right when viewing recordings in full size, and in the lower left corner of the thumbnail overview.

### Removing a tag

- Press the thumbwheel button
- or
- Tap the ★ icon

## DELETING RECORDINGS

There are several methods available to delete recordings:

- deleting individual recordings
- deleting multiple recordings
- deleting all recordings without a icon/ranking
- deleting all recordings



### Important

- Once deleted, recordings are no longer retrievable.

## DELETING INDIVIDUAL RECORDINGS



→ Tap the “Delete” icon 

- A confirmation prompt appears.
- The LED will flash during the delete process. The process may take a few seconds.
- The next recording will be displayed once deletion is complete. The message **No valid video to play** appears if no other recordings are saved on the card.

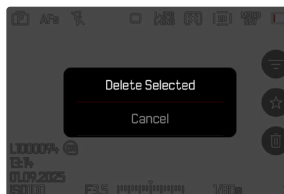

## Cancelling a deletion and returning to normal playback mode

→ Press the **PLAY** button

or

→ Select **Cancel**

### Note

- The Delete screen can be called up only by pressing the **MENU** button when in overview mode, because the menu function **Delete** of the “Play menu” is not available in this context.

## DELETING MULTIPLE RECORDINGS

You can highlight multiple recordings in a Delete overview with twelve thumbnails for simultaneous deletion.

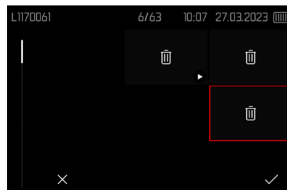

- Turn the thumbwheel to the left
  - The overview screen appears.
- Press the **MENU** button
- Select **Delete Multi**
  - The Delete overview appears.
  - Any number of recordings can be selected in this view.

## Selecting recordings for deletion

- Select a recording
  - Press the directional pad
- or
- Tap the desired recording
    - The images selected for deletion are marked.

## Deleting the selected recordings

- Press the **MENU** button
- Select **Delete Selected**

or

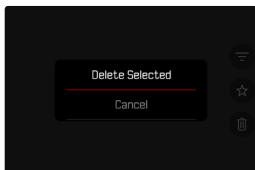
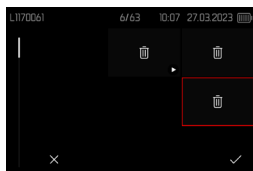

- Tap the “Delete” icon
- Select **Delete Selected**

## Cancelling a deletion and returning to normal playback mode

- Press the **MENU** button

## DELETING ALL UNRATED RECORDINGS

- Press the **MENU** button
- Select **Delete All without ★**

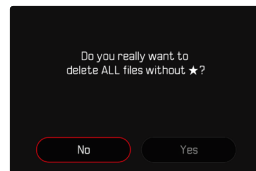
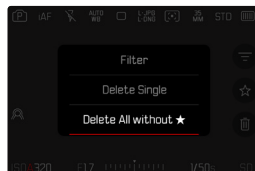

- The confirmation prompt **Do you really want to delete ALL files without ★?** appears.
- Select **Yes**
- The LED will flash during the deletion process. The process may take a few seconds. The next marked recording appears once deletion is complete. The message **No valid video to play** appears if no other recordings are saved on the card.



## PAUSE PLAYBACK

→ Tap anywhere on the LCD panel

or

→ Press the directional pad

## RESUMING PLAYBACK

### Using touch control

While the control elements are visible:

→ Tap anywhere on the LCD panel

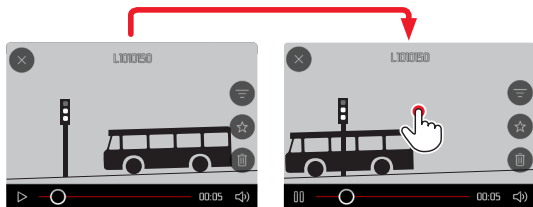

### Using button control

While the control elements are visible:

→ Press the center button

## NAVIGATE TO ANY POINT IN THE FILE

### QUICK JUMP

#### Using touch control

While the control elements are visible:

→ Tap the Playback status bar at the desired position

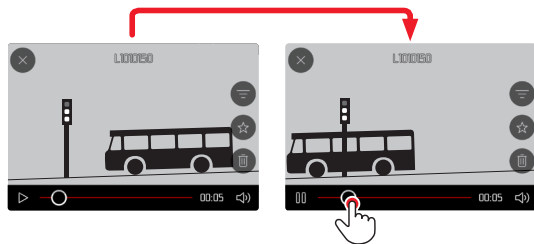

#### Using button control

→ Press and hold the directional pad

## PRECISE SELECTION

→ Turn the thumbwheel

## END PLAYBACK

### Using touch control

While the control elements are visible:

- Tap the "Go back" icon (⊗)

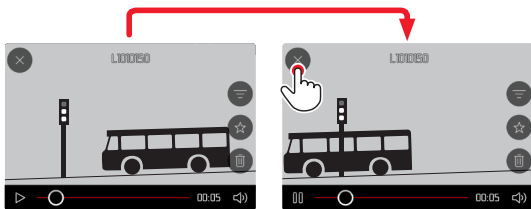

### Using button control

- Press the **PLAY** button

## SETTING THE VOLUME

### Using touch control

While the control elements are visible:

- Tap the volume icon
- Tap the volume bar at the desired position

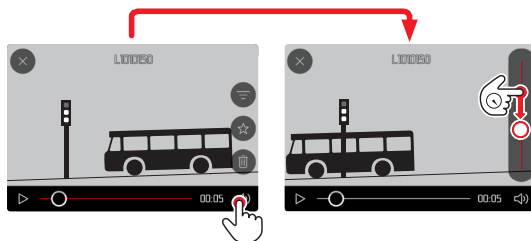

### Using button control

- Press the directional pad up/down
  - The volume bar appears.
- Press the directional pad up (louder) or down (quieter)

### **Note**

- Sound is switched off at the lowest part of the bar and the volume icon changes to 

## VIDEO EDITING

### Using button control

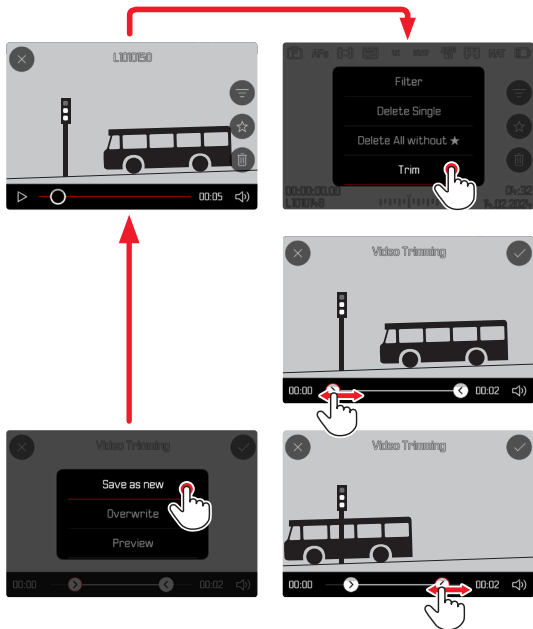

## ACCESSING THE VIDEO EDITING FUNCTION

- Press the **MENU** button
- Select **Video Trimming**
  - The video cutting screen appears, the left cutting mark is highlighted in red (= active).

## CHANGING THE CURRENT CUTTING POINT

- Press the directional pad left/right
  - The selected cutting point is highlighted in red (= active).

## MOVING THE ACTIVE CUTTING POINT

- Turn the thumbwheel
  - The currently selected time of the relevant cutting point is displayed at the bottom left of the footer line. A still of the video sequence at that point is displayed in the background.

## CUTTING

- Tap the “Confirm” icon
  - The **Video Trimming** menu appears.
- Select a function from the **Video Trimming** menu (**Save as new**, **Overwrite**, **Preview**)

<b>Save as new</b>	The new video is <b>additionally</b> saved, the original video remains unchanged.
<b>Overwrite</b>	The newly cut video is saved and the original one is deleted.
<b>Preview</b>	The new video is played. The newly cut video is not saved and the original remains unchanged.

## Notes

- In all three cases, a notification screen appears while the data is being processed. Then the new video is played back.
- The numbering of existing recordings will not be changed when **Save as new** is selected. The newly created video will be added to the end of the series of videos.

## CANCELLING THE VIDEO EDITING FUNCTION

The editing function can be canceled at any time, provided no selection was made in the **Video Trimming** menu.

- Tap the “Go back” icon (✕)
  - The video playback screen reappears.

## OTHER FUNCTIONS

The settings described in this chapter apply for photo and video mode alike. They are therefore available in the picture and video menu (see chapter “Camera Operation” under “Menu Control”). A setting selected in one of the modes will also apply to the other.

## RESETTING THE CAMERA TO FACTORY SETTINGS

This function allows you to reset all your custom menu settings back to the factory settings. You can optionally exclude the user profiles, Wi-Fi and Bluetooth settings, as well as the image numbering from the reset individually.

- Select **Camera Settings** in the main menu
- Select **Reset Camera**
  - The prompt **Do you want to reset the camera settings?** appears.
- Confirm **(Yes)** or reject **(No)** restoring the default settings
  - Selecting **No** will cancel the reset and the display will return to the main menu. Selecting **Yes** will trigger additional prompts regarding the settings you can opt to keep.
- Confirm **(Yes)** or reject **(No)** resetting the user profiles
- Confirm **(Yes)** or reject **(No)** the reset of the Wi-Fi and Bluetooth settings
- Confirm **(Yes)** or reject **(No)** resetting the image numbering
- Confirm **(Yes)** or reject **(No)** the reset of the LUT profiles
- Confirm **(Yes)** or reject **(No)** the reset of the Leica Looks profiles
  - The message **Please Restart the Camera** appears.
- Switch the camera off and on again

## Notes

- Date & time, as well as the preferred language will have to be set up again after a reset. Relevant prompts will appear on screen.
- You reset the image numbering separately via the menu item **Reset Image Numbering** (see p. 208).

## FIRMWARE UPDATES

Leica is continuously working on the further improvement and optimization of your camera. Since many camera functions are entirely controlled by software, some of these improvements and additions to the functional scope can be installed in retrospect. Leica offers firmware updates at irregular intervals, which you can download from our website.

Leica will notify you of any new updates, once you have registered your camera. Users of Leica FOTOS will also be automatically notified about firmware updates for their Leica cameras.

There are two options for installing firmware updates.

- conveniently via the Leica FOTOS app (see p. 212)
- directly via the camera menu

## Finding the currently installed firmware version

- Select **Camera Information** in the main menu
- The current firmware version is displayed next to the menu item **Camera Firmware Version**.

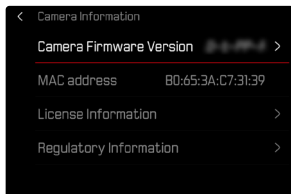

More information about registering, firmware updates and how to download them to your camera, as well as any amendments and additions to this manual can be found in the customer area of our website at:

<https://club.leica-camera.com>

## EXECUTING A FIRMWARE UPDATE

Any interruption of a running firmware update may cause serious and irreparable damage to your equipment!

You will therefore have to take particular note of the following, when carrying out a firmware update:

- Do not switch off the camera!
- Do not remove the memory card!
- Do not remove the rechargeable battery!

### Notes

- A warning message will appear if the battery is insufficiently charged. Recharge the battery and then repeat the process described above.
- You will find additional device and country-specific registration marks and numbers in the **Camera Information** submenu.

## PREPARATION

- Fully charge and insert the rechargeable battery
- Any stored firmware files on the memory card must be removed
  - We recommend saving any images on the memory card and reformatting it before the update.  
(Caution: Loss of data! All data stored on the memory card will be lost during formatting.)
- Download the latest firmware version
- Save the download to the memory card
  - The firmware file must be stored in the main directory of the memory card (not in a sub-directory).
- Insert the memory card into the camera
- Switch the camera on

## UPDATING THE CAMERA FIRMWARE

- Preparation
- Select **Camera Information** in the main menu
- Select **Camera Firmware Version**
- Select **Firmware Update**
- Select **Start Update**
  - A prompt with information about the camera is displayed.
- Check the version information
- Select **Yes**
  - The update will start automatically.
  - The status LED will flash during this process.
  - Once the process has completed successfully, a relevant on-screen message and prompt to restart the device will appear on screen.
- Switch the camera off and on again

### Notes

- These settings will be applied automatically if the update is loaded via Leica FOTOS.
- All camera settings (including date and time) will be saved automatically and applied after the update.

## LEICA FOTOS

The camera can be controlled remotely using a smartphone/tablet PC. This will require an installation of the Leica FOTOS app on the mobile device. Leica FOTOS furthermore offers a variety of other useful functions:

- Geotagging for images
- File transfer
- Downloading firmware updates
- Self-timer delay time selection via remote control, e.g. for group photographs
- Loading and transferring Leica Looks

A list of available functions and instructions for their use can be found in the Leica FOTOS app. Please read the legal notes on page 4.

→ Scan the following QR code with the mobile device



or

→ The app is available from Apple App Store™/Google Play Store™

## SELECTING A WI-FI BAND

Leica Q3 43 supports the use of various Wi-Fi frequencies in a number of regions.

- Select **Camera Settings** in the main menu
- Select **Wi-Fi**
- Select **Wi-Fi band**
- Select the desired setting

### Note

- The menu item will appear grayed out, where this option is unavailable.
- Some countries regulate usable bandwidths. Should the camera fail to connect to the smartphone (Leica FOTOS), it may be necessary to set the Wi-Fi band to 2.4 GHz to establish a connection.

## CONNECTIVITY (iPhone users)

### FIRST-TIME CONNECTION TO A MOBILE DEVICE

The connection is established via WLAN. A pairing of the camera and the mobile device is required for a first-time connection to a mobile device. A connection is established via the connection wizard at initial setup of the camera or later via the menu.

### CONNECTION WIZARD

The connection wizard appears at initial startup of the camera or after a camera reset. These settings are also available via the menu item **Leica FOTOS**.

The following screen appears after you have selected the language.

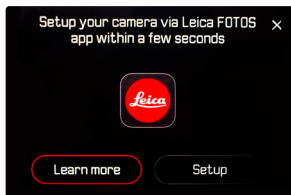

#### Starting the connection wizard

→ Select **Setup** or **Learn more**

#### Exiting the connection wizard

→ Tap the icon in the top right corner of the screen

## IN THE CAMERA



→ Select **iOS**

→ Select **Next**

→ Wait until the QR code appears on the LCD panel

### ON THE MOBILE DEVICE

→ Launch the Leica FOTOS app

→ Select “Add Camera”

→ Select the camera model

- Connection is being established. The process may take a few seconds.
- Once successfully connected, the Status LED will light briefly, and the camera displays a relevant message.

## USING THE MENU TO

Where the connection wizard was not used or other mobile devices should be connected, the same settings are always accessible via the menu item **Leica FOTOS**.

### IN THE CAMERA

- Select **Leica FOTOS** in the main menu
- Select **Pairing**
- Wait until the QR code appears on the LCD panel

### ON THE MOBILE DEVICE

- Launch the Leica FOTOS app
- Select “Add Camera”
- Select the camera model
  - Connection is being established. The process may take a few seconds.
  - Once successfully connected, the Status LED will light briefly, and the camera displays a relevant message.

### Notes

- The pairing process may take a few minutes to complete.
- Each mobile device only needs to be paired with the camera once. The process adds the device to the list of known devices.
- The Bluetooth function is disabled if the connectivity mode **Off** is selected (see p. 217). **Pairing** will not be available, and the relevant menu item will be grayed out.

## CONNECTING WITH PAIRED DEVICES

### VIA LEICA FOTOS CABLE (for iPhone only)

The Leica FOTOS Cable makes connectivity particularly easy and quick.

- Connect the camera and mobile device via the Leica FOTOS cable
  - The connection is established automatically.

### Note

- USB mode must be set to **Apple MFi** or **Select on Connection** to ensure an automatic connection via the Leica FOTOS Cable.

### VIA WI-FI

#### IN THE CAMERA

- Select **Leica FOTOS** in the main menu
- Select **Connectivity**
- Select **Performance Mode** or **Eco Mode**

#### ON THE MOBILE DEVICE

- Launch the Leica FOTOS app
- Select the camera model
- Confirm the prompt
  - The camera connects to the mobile device automatically.

## CONNECTIVITY (Android users)

### FIRST-TIME CONNECTION TO A MOBILE DEVICE

The connection is established via WLAN. A pairing of the camera and the mobile device is required for a first-time connection to a mobile device. A connection is established via the connection wizard at initial setup of the camera or later via the menu.

### CONNECTION WIZARD

The connection wizard appears at initial startup of the camera or after a camera reset. These settings are also available via the menu item **Leica FOTOS**.

The following screen appears after you have selected the language.

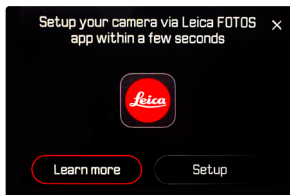

#### Starting the connection wizard

→ Select **Setup** or **Learn more**

#### Exiting the connection wizard

→ Tap the icon in the top right corner of the screen

## IN THE CAMERA

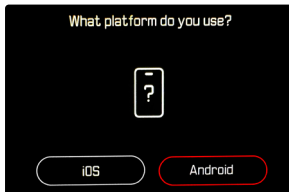

→ Select **Android**

→ Select **Next**

→ Wait until the QR code appears on the LCD panel

### ON THE MOBILE DEVICE

→ Launch the Leica FOTOS app

→ Select "Add Camera"

→ Select the camera model

- Connection is being established. The process may take a few seconds.
- Once successfully connected, the Status LED will light briefly, and the camera displays a relevant message.

## USING THE MENU TO

Where the connection wizard was not used or other mobile devices should be connected, the same settings are always accessible via the menu item **Leica FOTOS**.

### IN THE CAMERA

- Select **Leica FOTOS** in the main menu
- Select **Pairing**
- Wait until the QR code appears on the LCD panel

### ON THE MOBILE DEVICE

- Launch the Leica FOTOS app
- Select “Add Camera”
- Select the camera model
- Select “Scan the QR code”
- Scan the QR code
  - Connection is being established. The process may take a few seconds.
  - Once successfully connected, the Status LED will light briefly, and the camera displays a relevant message.

### Notes

- The pairing process may take a few minutes to complete.
- Each mobile device only needs to be paired with the camera once. The process adds the device to the list of known devices.
- The Bluetooth function is disabled if the connectivity mode **Off** is selected (see p. 217). **Pairing** will not be available, and the relevant menu item will be grayed out.

## CONNECTING WITH PAIRED DEVICES

### IN THE CAMERA

- Select **Leica FOTOS** in the main menu
- Select **Connectivity**
- Select **Performance Mode** or **Eco Mode**

### ON THE MOBILE DEVICE

- Launch the Leica FOTOS app
- Select the camera model
- Confirm the prompt
  - The camera connects to the mobile device automatically.

## CONNECTIVITY MODES

Three connection options are available.

Factory setting: **Performance Mode**

- Select **Leica FOTOS** in the main menu
- Select **Connectivity**
- Select **Performance Mode/Eco Mode/Off**

	<b>Faster connection</b> (Factory setting)	<b>Extended battery life</b>	<b>All RF connections deactivated</b>
	<b>Performance Mode</b>	<b>Eco Mode</b>	<b>Off</b>
<b>Bluetooth</b> (Geotagging)	On	On	-
<b>Wi-Fi</b> (Data transfer) (Remote control)	The Leica FOTOS connection remains active.	Automatic On / Off The connection to the Leica FOTOS app is established automatically as needed, and disconnected after ≥ 5 min. of inactivity	-
<b>Wi-Fi Sleep Timer</b>	Never	After 5 min	-
<b>Remote Camera Activation</b>	Always available	This function is available up to 7 days after the camera was switched off	-

## PERFORMANCE MODE

Bluetooth is permanently activated, allowing anytime Geotagging (where enabled). Wi-Fi is similarly permanently activated. This option offers the fastest access to Leica FOTOS and therefore an excellent user experience.

- Select **Leica FOTOS** in the main menu
- Select **Connectivity**
- Select **Performance Mode**

## ECO MODE

Bluetooth is permanently activated, allowing anytime Geotagging (where enabled). Camera Wi-Fi will be enabled only during the transfer of settings or files, and will otherwise remain off. This is a power saving option.

- Select **Leica FOTOS** in the main menu
- Select **Connectivity**
- Select **Eco Mode**

## AIRPLANE MODE (Off)

All RF connections will be deactivated if this option is selected.

- Select **Leica FOTOS** in the main menu
- Select **Connectivity**
- Select **Off**

## EXECUTING A FIRMWARE UPDATE

Any interruption of a running firmware update may cause serious and irreparable damage to your equipment!

You will therefore have to take particular note of the following, when carrying out a firmware update:

- Do not switch off the camera!
- Do not remove the memory card!
- Do not remove the rechargeable battery!
- Do not detach the lens!

Leica FOTOS will notify you when firmware updates are available for your Leica cameras.

- Follow the instructions provided by the Leica FOTOS app

### Notes

- A warning message will appear if the battery is insufficiently charged. Recharge the battery and then repeat the process described above.
- Alternatively, firmware updates can also be installed via the camera menu (see p. 209).

## REMOTE CAMERA CONTROL

You can take pictures and record video remotely via the mobile device, and can also change image settings or transfer data to the mobile device. A list of available functions and instructions for their use can be found in the Leica FOTOS app.

### REMOTE CAMERA ACTIVATION

When this function is activated, the switched-off camera can be switched on remotely. The Bluetooth function must be active.

- Select **Leica FOTOS** in the main menu
- Select **Connectivity**
- Select **Performance Mode/Eco Mode**
  - The camera will scan for known devices and automatically establishes a connection.

### Important information

- Remote activation will activate the camera even if it was switched off via the main switch.
- Accidental remote camera activation may result in unwanted pictures taken and excessive power consumption.
- A third-party device can – provided it has been paired with the camera – access the camera remotely if your own mobile device is not currently connected or its Bluetooth function is deactivated. This poses a danger of unauthorized access to your data or camera functions.

### Solution

- Only activate this function just before you want to use it.
- Disable the function as soon as it is no longer needed.

## CARE/STORAGE

We recommend the following if the camera will not be used for an extended period of time:

- Switch off the camera
- Remove the memory card
- Remove the battery (after approx. 2 months the set date and time will be lost)

## CAMERA HOUSING

- Keep your equipment meticulously clean, as any kind of dirt residue presents a breeding ground for micro organisms.
- Only clean the camera with a soft, dry cloth. Stubborn dirt should first be moistened with a watered-down detergent and can then be wiped away with a dry cloth.
- Wet a soft cloth with tap water, wring it out thoroughly and use it to wipe down the camera. Then wipe it down thoroughly with a dry cloth.
- Wipe the camera with a clean, lint-free cloth to remove stains and fingerprints. Tougher dirt in hard to reach corners of the camera housing can be removed with a small brush. Take care not to touch the shutter blades.
- Store the camera in a closed and padded container to prevent friction damage and protect it against dust accumulation.
- Keep the camera in a dry, sufficiently ventilated place, where it will not be subjected to high temperatures and humidity. Make sure to remove all moisture from the camera if it was used in humid conditions.
- Do not store the camera in a leather case for extended periods of time to prevent fungal contamination.
- Empty your camera bag completely if it ever gets wet during use. Your equipment might otherwise be subjected to moisture and tanning residue released by the moist leather.

- All mechanical bearings and sliding surfaces on your camera are lubricated. Remember to press the shutter button several times every three months to prevent the lubrication points hardening if the camera will not be used for an extended period of time. We also recommend repeated adjustment and use of all the other operating elements.
- When using your camera in tropical climates, make sure to expose the equipment to sunlight and fresh air as much as possible to prevent fungal growth. Storage in airtight containers or cases is recommended only in conjunction with a desiccant like silica gel.

## LENS

- A soft-bristle brush will usually suffice to remove dust from the outer lenses. Remove more severe soiling with a clean, soft cloth that is completely free of foreign matter. Wipe the lens in a circular motion from the center outward. We recommend using microfiber cloths that come in a protective container and are available from photography shops and other optical retailers. These cloths are machine-washable at 40°C. Do not use fabric softener and do not iron them. Never use spectacle lens cleaning cloths, as these are soaked in chemicals, which could damage the glass of the camera lenses.
- Attach a transparent UVA filter for optimal front lens protection in unfavorable conditions (e.g. sand, salt water spray). Please remember that the filter may create unwanted light reflections in some backlight situations and in case of high contrasts.
- Lens caps also protect the lens against accidental fingerprint smudges and rain.
- All mechanical bearings and sliding surfaces on your lens are lubricated. Make sure to periodically move the focus ring and the aperture ring to prevent seizing if the lens will not be used for an extended period of time.

## VIEWFINDER/LCD PANEL

- Switch off your camera and leave it to stand at room temperature for around 1 hour if condensation has formed on or in the camera. The condensation will disappear, once the camera temperature has reached room temperature.

## RECHARGEABLE BATTERY

- Lithium-ion rechargeable batteries should only be stored partially charged, i.e. not fully depleted or fully charged. The camera LCD panel will show the current charge level of the battery. Charge the battery twice a year for around 15 minutes to avoid deep discharge in case of very long storage periods.

## MEMORY CARDS

- Make sure to store memory cards in their anti-static container when not in use.
- Do not store memory cards where they will be exposed to high temperatures, direct sunlight, magnetic fields or static electricity. Always remove the memory card if the camera will not be used for an extended period of time.
- We recommend formatting memory cards from time to time, as fragmented residual data from deleted files may block some of the storage capacity.

## SENSOR

### PIXEL MAPPING

Defective pixels may appear on the image sensor of digital cameras over time. The camera compensates for these defective pixels automatically by calculating the data captured by other pixels surrounding defective ones. This feature requires a process known as “pixel mapping” to recognize and register defective pixels. The camera does this automatically every two weeks. The function can also be accessed manually if needed.

- Select **Camera Settings** in the main menu
- Select **Pixel Mapping**
- Select **Yes**
  - Pixel mapping is executed. The process may take a few seconds.
  - The message **Please Restart the Camera** appears.
- Switch the camera off and on again

### Note

- This function is unavailable if the sensor is warmed up.

# FAQ

Problem	Possible causes to check	Troubleshooting suggestions
<b>Battery issues</b>		
Battery is depleted too quickly	Battery too cold	Warm the battery (e.g. in pants pocket) and only insert directly before use
	Battery too hot	Allow battery to cool down
	LCD panel or EVF set too bright	Reduce brightness
	Power save mode deactivated	Activate <b>Auto Power Off</b>
	AF mode permanently activated	Select other mode
	Permanent WLAN connection	Deactivate WLAN when not in use
	Continuous use of LCD panel (e.g. in Live View mode)	Deactivate the function
	Battery has been recharged too many times	The battery has reached the end of its operating time Replace battery
	Tracking-AF with AFc activated	Use AFs or MF
	Preview of the recorded images ( <b>Auto Review</b> ) activated	Deactivate the function
Charging process not starting	Incorrect battery polarization or faulty charger connection	Check polarization and connection
Charging takes too long	Battery too hot or too cold	Charge the battery at room temperature
Charging pilot light is on, but battery isn't charging	The battery contacts are dirty	Clean the contacts with a soft, dry cloth
	Battery has been recharged too many times	The battery has reached the end of its operating time Replace battery
<b>Camera problems</b>		
The camera suddenly switches itself off	Battery is depleted	Charge or replace the battery
The camera won't switch on	Battery is depleted	Charge or replace the battery
	Battery too cold	Warming the battery (e.g. in pants pocket)
The camera switches off again immediately after it is switched on	Battery is depleted	Charge or replace the battery
Camera is heating up	Heat development due to high-res video recording (4K) or serial exposures with DNG	Not a fault; allow camera to cool down if it gets too hot
Camera does not recognize the memory card	The memory card is not compatible or defective	Replace the memory card
	Memory card is incorrectly formatted	Format the memory card in the camera (Caution: Loss of data!)

<b>Menus and displays</b>		
Electronic viewfinder is dark	EVF brightness is set too low	Set the EVF brightness
Display language is not English	-	Select <b>English</b> in the <b>Language</b> menu
Electronic viewfinder is dark	Switchover between EVF and LCD incorrectly set	Select a suitable setting
Viewfinder is out of focus		Check the diopter setting and adjust as needed
The LCD panel is too dark or too bright/not clear	The brightness setting is incorrect	Adjust the display brightness
	Viewing angle is too small	View the LCD panel at a perpendicular angle
	Brightness sensor is blocked	Make sure that the brightness sensor is not blocked
Live View stops suddenly or doesn't start	The camera is hot due to high ambient temperature, extended Live View operation, extended video shooting or continuous shooting	Allow camera to cool down
The brightness in Live View mode is not the same as in the images	The brightness settings for the LCD panel have no influence over the exposures	Adjust the brightness settings as needed
	Exposure preview is deactivated	Activate the function
The number of remaining shots does not count down after shooting	The image requires only very little memory space	This is not a fault; the number of remaining shots is calculated as approximations
<b>Shooting</b>		
Image noise appears on the LCD panel/in the viewfinder when the shutter button is pressed to the first pressure point	The gain is increased to aid image composition if the object is insufficiently lit with reduced lens aperture	Not a fault – image quality will not be impacted
LCD panel/viewfinder deactivates after a very short time	Power Save settings are activated	Change the settings as needed
The display switches off after shooting/the LCD panel goes dark after shooting	Flash loads after shooting, LCD panel deactivates during load time	Wait until the flash is charged
Flash won't fire	The flash cannot be used with the current settings	Refer to the list of flash function-compatible settings
	Battery is depleted	Charge or replace the battery
	Pressing the shutter button while flash is still loading	Wait until the flash is loaded
	Electronic shutter function is selected	Change the setting
	Automatic bracketing or continuous shooting is activated	Change the setting

The flash does not fully illuminate the object	Object is outside the flash range	Move object into flash range
	Flash is covered	Make sure the flash unit is not covered by your finger or some object
The camera won't release/shutter button is deactivated/shooting not possible	Memory card is full	Replace the memory card
	The memory card is not formatted	Reformat the memory card (Caution: Loss of data!)
	The memory card is write protected	Deactivate the write protection on the memory card (small lever on the side of the memory card)
	Dirt on the memory card contacts	Clean the contacts with a soft cotton or linen cloth
	The memory card is damaged	Replace the memory card
	The sensor is overheating	Allow camera to cool down
	The camera has switched off automatically (Auto Power Off)	Switch the camera back on Deactivate auto standby as needed
	Image data is being written to the memory card and the cache is full	Wait
	Noise reduction function is working (e.g. after night photography with long exposure times)	Wait or deactivate noise reduction
	Battery is depleted	Charge or replace the battery
	Camera is processing a image	Wait
Image numbering has reached its limit	See section "Data Management"	
Image does not sharpen automatically	AF is deactivated	Activate AF
No face detection/faces are not recognized	Face is covered (sunglasses, hat, long hair, etc.)	Remove distracting objects
	Face takes up to little space in the picture composition	Change image composition
	Face is tilted or horizontal	Keep face straight
	Camera not held straight	Hold camera straight
	Face is insufficiently lit	Use flash, improve illumination
Camera selects incorrect object	The incorrectly selected object is closer to the image center than the main object	Change the image section or take picture using the focus lock
	The incorrectly selected object is a face	Deactivate face detection
No continuous shooting available	The camera is overheated and the function was temporarily disabled to protect the camera	Allow camera to cool down
The image on the LCD panel displays lots of noise	Light enhancement function of the LCD panel in dark surroundings	Not a fault – image quality will not be impacted

Image storage takes a long time	Noise reduction is activated for long-term exposures	Deactivate the function
	The memory card inserted is slow	Use a suitable memory card
Manual white balance is unavailable	The image object is too bright or too dark	
Camera does not focus	Desired object part is too close to the camera	Select Macro mode
	Desired object part is very far away	Exit Macro mode
	Object not suitable for AF	Use Focus lock or select manual focus
AF frame is framed in red with activated AF; images out of focus	Focusing was unsuccessful	Try to focus again
No AF frame selectable	Focus ring not in AF position	Turn the focus ring to the AF position
	Automatic Metering Field Control or Face Detection in AF Mode is selected	Select other control mode
	One of the scene modes is currently active	Select the <b>P-A-S-M</b> setting under <b>Scene Mode</b>
	Image review is activated	Deactivate image review
	Camera is in Standby mode	Press the shutter button to the first pressure point
AF assist lamp does not light up	Camera is in video shooting mode	Change the mode
	Function is deactivated	Activate AF
<b>Video recording</b>		
No video is recorded	The camera is overheated and the function was temporarily disabled to protect the camera	Allow camera to cool down
Video shooting stops	Maximum length of individual video sequence was reached	
	The memory card's write speed is too low for the selected video resolution/compression	Insert another memory card or change the storage method
<b>L-Log</b> is not selectable in video mode	A 10 bit format was not selected as the video format	Switch to 10 bit format or MOV in video format
<b>Review and photo management</b>		
Selected images cannot be deleted	Some of the selected images are write protected	Remove write protection (using the device with which the file was originally set to write protected)
File numbering does not start at 1	The memory card contains previously stored images	See section "Data Management"
The time and date settings are incorrect or are not displayed	The camera has not been in use for an extended period of time (the battery was removed)	Insert a charged battery and configure the correct settings

The time and date stamp on images are incorrect	Time settings are incorrect	Set the time correctly Caution: Time settings will be lost if the camera is not used/remains in storage with a depleted battery over an extended period of time
The time and date stamp on images are unwanted	Setting was ignored	Cannot be removed in retrospect Deactivate the function as needed
Images are damaged or missing	The memory card was removed while the readiness indicator was flashing	Never remove the memory card while the readiness indicator is flashing. Charge the battery.
	The memory card formatting is faulty or the card is damaged	Reformat the memory card (Caution: Loss of data!)
The most recent image is not displayed on the LCD panel	Preview is deactivated	Activate <b>Auto Review</b>
Parts of my video scenes are not fully in the picture	Difference of aspect ratios between camera and playback medium	Set the correct aspect ratio on the camera
<b>Image quality</b>		
The image is too bright	Light sensor was covered during shooting	Make sure that the light sensor is not obstructed
Image noise	Long exposure times (> 1s)	Activate the noise reduction function for long-term exposure
	ISO sensitivity set too high	Decrease ISO sensitivity
Round white stains, similar to soap bubbles	Flash photography in a very dark environment: reflections of dust particles	Deactivate the flash
Images are out of focus	Lens is dirty	Clean the lens
	Lens is obstructed	Make sure that lens is unobstructed
	Camera moved during shooting	Use flash
		Mount the camera on a tripod
Macro Function	Use faster shutter speeds	
Images are overexposed	Flash is activated in bright surroundings	Select the appropriate mode
	Strong light source in the image	Change the flash mode
	(Half) backlight falling into the lens (also from light sources outside the image range)	Avoid strong light sources in the image
	Selected exposure time is too long	Use the lens hood or change to another object
Out of focus/picture stabilizer not functioning	Shooting at a dark location without flash	Select a shorter exposure time
The image is grainy or there is image noise	Shooting at a dark location without flash	Use a tripod
	ISO sensitivity set too high	Decrease ISO sensitivity
Horizontal stripes	Picture was taken with electronic shutter under a light source like a fluorescent lamp	Try shorter shutter speeds

Unnatural colors and brightness	Shooting in artificial light or extreme brightness	Set white balance or select correct lighting presets
No images are displayed	No memory card inserted	Insert a memory card
	The photos were taken with another camera	Transfer the files to another device to view them
Images cannot be displayed	File name was changed on a PC	Use suitable software for file transfers from a PC to the camera
<b>Video quality</b>		
Video recordings show flickering/stripes	Light source interference in artificial lighting	Select a different frame rate (suitable for the local alternating current (AC) grid frequency) under <b>Video Format / Resolution</b>
Camera noise in video recording	The dials were used	Avoid using the dials during video shootings
No sound on video recording	Playback volume is set too low	Increase playback volume
	Microphone was covered during shooting	Make sure the microphone is not obstructed while shooting video
	Speakers are covered	Make sure that speakers are unobstructed during playback
	Microphone was deactivated while recording	Activate the microphone
Flickering or horizontal stripes in the video recording	CMOS sensors will display this phenomenon when light sources like LED lamps or fluorescent tubes are used	Quality may be improved by selecting a manual shutter speed (e.g. 1/100 s)
<b>Smartphones/WLAN</b>		
WLAN connection gets interrupted	Camera deactivates when it overheats (safety feature)	Allow camera to cool down
Cannot pair with a mobile device	The camera was already paired with the mobile device	Delete the camera registration from the Bluetooth settings in the mobile device and repeat pairing process
Mobile device connection/image transfer not working	The mobile device is too far away	Bring the devices closer to each other
	Interference from other devices in the vicinity, e.g. other smartphones or a microwave oven	Increase distance to interfering devices
	Interference from multiple mobile devices in the vicinity	Re-establish the connection/disconnect other mobile devices
	Mobile device is currently connected to another device	Check connection
Camera does not appear on the WLAN configuration screen of the mobile device	Mobile device does not recognize camera	Switch the WLAN function of the mobile device off and on again

# MENU OVERVIEW

## FUNCTION BUTTONS

The following control elements are available for direct access (see p. 54).

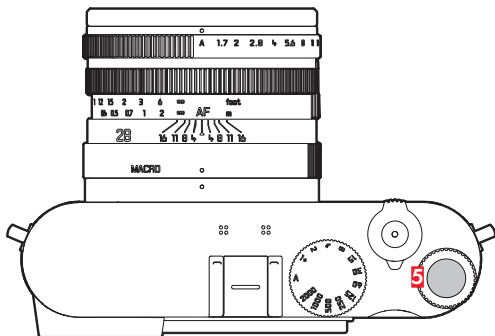

5 Thumbwheel button

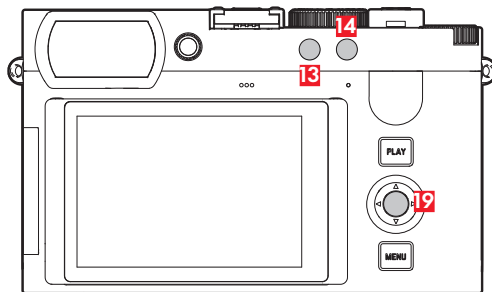

- 13 FN button 1
- 14 FN button 2
- 19 Center button

## LEGEND

■ Control Center factory settings

■ Available for Control Center

● Factory setting on the function buttons

● Available for function buttons

## DIRECT ACCESS

Function	PHOTO		VIDEO	
	Control Center	Function buttons	Control Center	Function buttons
Photo - Video*	■	● (14)	■	● (14)
Toggle Info Levels		● (19)		● (19)
Digital Zoom		● (5) (13) (14) (19)		● (13)
Exposure lock				
AF-L + AE-L		● (5) (13) (14) (19)		
AE-L		● (5) (13) (14) (19)		
AF-L		● (5) (13) (14) (19)		
Toggle Video Gamma				
Magnification		● (5) (13) (14) (19)		● (5) (13) (14) (19)
Toggle Focus Point		● (5) (13) (14) (19)		
AF Frame Size		● (5) (13) (14) (19)		● (5) (13) (14) (19)
<b>Focusing</b>				
Focusing		● (5) (13) (14) (19)		● (5) (13) (14) (19)
Focus Mode	■	● (5) (13) (14) (19)	■	● (5) (13) (14) (19)
Intelligent AF				
AFs				
AFc				
AF Mode	■	● (5) (13) (14) (19)	■	● (5) (13) (14) (19)
AF Detection	■	● (5) (13) (14) (19)	■	● (5) (13) (14) (19)
AF Assist Lamp		● (5) (13) (14) (19)		
Auto Magnification		● (5) (13) (14) (19)		● (5) (13) (14) (19)
Touch AF				
Touch AF		● (5) (13) (14) (19)		● (5) (13) (14) (19)
Touch AF + Release				
Touch AF in EVF		● (5) (13) (14) (19)		● (5) (13) (14) (19)
AF Quick Setting only				
<b>Exposure</b>				
Exposure Metering	■	● (5) (13) (14) (19)	■	● (5) (13) (14) (19)
Exposure Compensation	■	● (5) (13) (14) (19)	■	● (5) (13) (14) (19)
ISO Settings	■	● (5)	■	● (5) (13) (14) (19)

\* Some function are available only via direct access. These are listed at the top of the table.

ISO		● 5 13 14 19		● 5 13 14 19
Auto ISO Settings		● 5 13 14 19		● 5 13 14 19
White Balance	■	● 5 13 14 19	■	● 5 13 14 19
Gray card		● 5 13 14 19		● 5 13 14 19
Color Temperature		● 5 13 14 19		● 5 13 14 19
<b>Photo</b>				
Drive Mode	■	● 5 13 14 19		
Continuous Shooting				
Interval Shooting		● 5 13 14 19		
Exposure Bracketing		● 5 13 14 19		
Self-timer	■	● 5 13 14 19		
Photo File Format	■	● 5 13 14 19		
JPG Settings				
iDR	■	● 5 13 14 19	■	● 5 13 14 19
Noise Reduction (JPG)				
Leica Looks	■	● 5 13 14 19	■	● 5 13 14 19
Scene Mode	■	● 5 13 14 19	■	
Long exposure noise reduction		● 5 13 14 19		
Perspective Control	■	● 5 13 14 19		
Optical Image Stabilization	■	● 5 13 14 19	■	● 5 13 14 19
Photo Aspect Ratio	■	● 5 13 14 19		
Flash Settings	■	● 5 13 14 19		
Flash Mode				
Flash Exp. Compensation		● 5 13 14 19		
Flash Sync				
<b>Customization</b>				
Customize Control				
Digital Zoom Steps	■		■	
FN Buttons				
Thumbwheel		● 5 13 14 19		● 5 13 14 19
Dial Lock		● 5 13 14 19		● 5 13 14 19
Touch Icons (play mode)				
Capture Assistants		● 5 13 14 19		● 5 13 14 19

Focus Peaking		● 5 13 14 19		● 5 13 14 19
Clipping		● 5 13 14 19		
Zebra				● 5 13 14 19
Framelines				● 5 13 14 19
Storage Management				
Format Storage	■	● 5 13 14 19	■	● 5 13 14 19
Edit File Name				
Shutter Type	■	● 5 13 14 19		
Auto Review		● 5 13 14 19		
Group Display Mode		● 5 13 14 19		
Exposure Preview		● 5 13 14 19		
<b>Connectivity</b>				
Leica FOTOS	■	● 5 13 14 19	■	● 5 13 14 19
USB Settings	■	● 5 13 14 19		● 5 13 14 19
USB Charging		● 5 13 14 19		● 5 13 14 19
USB Mode		● 5 13 14 19		● 5 13 14 19
USB Microphone				● 5 13 14 19
<b>System</b>				
User Profile	■	● 5 13 14 19	■	● 5 13 14 19
Camera Settings	■		■	
Display Settings				
EVF-LCD		● 5 13 14 19		● 5 13 14 19
Eye Sensor Sensitivity				
LCD Brightness				
LCD Color Adjustment				
EVF Brightness				
EVF Color Adjustment				
EVF Frame Rate				
Rotate Info Bars				
Power Saving				
Auto Power Off				
Displays/AF Auto Off				
Battery Condition				

Date & Time			
Time Zone			
Daylight Saving Time			
Date Setting			
Time Setting			
Wi-Fi			
Wi-Fi band			
Network (SSID)			
Security			
Password			
Reset Camera			
Reset Image Numbering			
Pixel Mapping			
Acoustic Signal	●	(5) (13) (14) (19)	● (5) (13) (14) (19)
Volume			
Electronic Shutter Sound			
AF Confirmation			
Notification Signals			
Camera Information			
Copyright Information			
Language			
<b>Video</b>			
Video Profiles		■	● (5) (13) (14) (19)
Video Gamma		■	
Log Settings		■	● (5) (13) (14) (19)
HLG Settings			
L-Log Settings			
LUT Profile			● (5) (13) (14) (19)
Custom LUT			
HDMI with Audio			
Audio			
Microphone Gain		■	● (5) (13) (14) (19)
Wind Noise Reduction			● (5) (13) (14) (19)

## DIRECT ACCESS IN REVIEW MODE

Function	Review (photo)/Playback (video)	
	Play Menu	Function buttons
Toggle Info Levels		● (19)
Rate / Unrate	●	● (14)
EVF-LCD		●
Zoom (photos only)		● (5)
Delete Single	●	● (13)
Delete Multi	●	●
Delete Unrated	●	●
Delete All	●	●
Slideshow	●	●

# TECHNICAL DATA

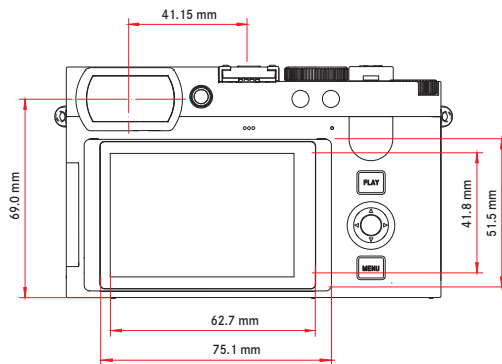
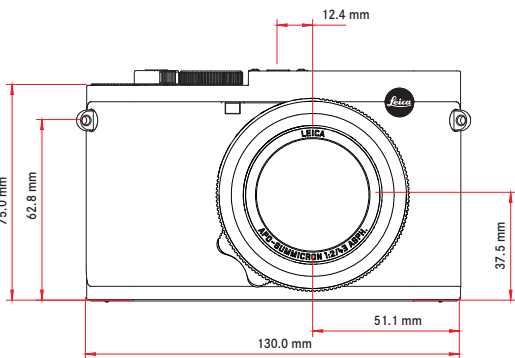
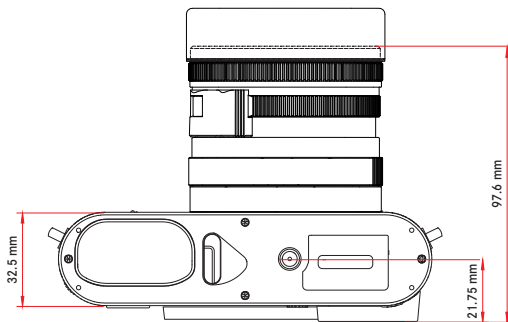
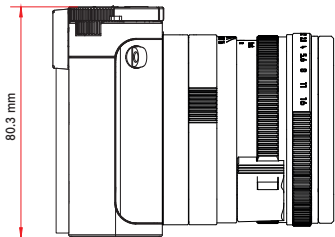

# LEICA Q3 43

## CAMERA

### Designation

Leica Q3 43

### Camera type

Digital 35 mm compact camera

### Type No.

6506

### Order No.

19084 (EU/US/CN), 19085 (JP), 19086 (ROW)

### Buffer memory

8 GB

Capacity, depending on frame rate and picture format, estimated quantity (number of possible images in the buffer memory)

	DNG	DNG + JPG	JPG
15 fps	63	63	67
9 fps	70	66	76
7 fps	74	69	83
5 fps	79	70	90
4 fps	83	72	104
2 fps	164	88	947

### Storage medium

UHS-II (recommended), UHS-I, SD/SDHC/SDXC memory card

### Material

Full metal housing: magnesium die-cast, leather covering, protection type IP52

### Operating conditions

0°C to +40°C

### Interfaces

ISO accessory shoe with additional control contacts for Leica flash units, HDMI jack Type D, USB 3.1 Gen 2 Type C up to 10 Gbps

### Tripod thread

A 1/4 DIN 4503 (1/4") with stainless steel in the base

### Dimensions

130 x 80 x 97.6 mm

### Weight

Approx. 793 g/709 g (with/without battery)

## SENSOR

### Sensor size

CMOS sensor, 62.39 MP/60.3 MP (total/effective)

### Processor

Leica Maestro series (Maestro IV)

### Filter

RGB color filter, UV/IR filter, no low-pass filter

### File formats

Photo: DNG™ (raw data), DNG + JPG, JPG (DCF 2.0, Exif 3.0)

Video:

MP4	h.265	AAC	48 kHz/16 bit
	h.264	AAC	48 kHz/16 bit
MOV	h.265	LPCM	48 kHz/24 bit
	h.264	LPCM	48 kHz/24 bit
	ProRes	LPCM	48 kHz/24 bit

### Image resolution

DNG™	9520 x 6336 pixels (60.3 MP)
	7404 x 4928 pixels (36.5 MP)
	5288 x 3518 pixels (18.6 MP)
JPG	9520 x 6336 pixels (60.3 MP)
	7392 x 4928 pixels (36.4 MP)
	5280 x 3512 pixels (18.5 MP)

### File size

DNG™	Approx. 70 MB, depending on resolution and image content
JPG	Depending on resolution and image content
Video	Max. length: 29 min

## Color depth

DNG™: 14 bit

JPG: 8 bit

## Color space

Photo: sRGB

## Video Resolution

	Resolution	Aspect ratio
<b>C8K</b>	8192 x 4320	17:9
<b>8K</b>	7680 x 4320	16:9
<b>C4K</b>	4096 x 2160	17:9
<b>4K</b>	3840 x 2160	16:9
<b>Full HD</b>	1920 x 1080	16:9

## Video frame rate / bit rate

<b>MOV C8K</b>					
MOV C8K (recording to SD)					
29.97 fps	C8K 4:2:0 / 10 bit	h.265	L-GOP	300 Mbps	
25.00 fps	C8K 4:2:0 / 10 bit	h.265	L-GOP	300 Mbps	
24.00 fps	C8K 4:2:0 / 10 bit	h.265	L-GOP	300 Mbps	
23.98 fps	C8K 4:2:0 / 10 bit	h.265	L-GOP	300 Mbps	
MOV C8K (HDMI output without HLG/L-Log and without recording to SD)					
29.97 fps	8K 4:2:0 / 8 bit	h.265	L-GOP	300 Mbps	
25.00 fps	8K 4:2:0 / 8 bit	h.265	L-GOP	300 Mbps	
24.00 fps	8K 4:2:0 / 8 bit	h.265	L-GOP	300 Mbps	
23.98 fps	8K 4:2:0 / 8 bit	h.265	L-GOP	300 Mbps	
MOV C8K (HDMI output with HLG/L-Log or during recording to SD)					
29.97 fps	C4K 4:2:2 / 10 bit	h.265	L-GOP	300 Mbps	
25.00 fps	C4K 4:2:2 / 10 bit	h.265	L-GOP	300 Mbps	
24.00 fps	C4K 4:2:2 / 10 bit	h.265	L-GOP	300 Mbps	
23.98 fps	C4K 4:2:2 / 10 bit	h.265	L-GOP	300 Mbps	
<b>MOV 8K</b>					
MOV 8K (recording to SD)					
29.97 fps	8K 4:2:0 / 10 bit	h.265	L-GOP	300 Mbps	
25.00 fps	8K 4:2:0 / 10 bit	h.265	L-GOP	300 Mbps	
24.00 fps	8K 4:2:0 / 10 bit	h.265	L-GOP	300 Mbps	
23.98 fps	8K 4:2:0 / 10 bit	h.265	L-GOP	300 Mbps	
MOV 8K (HDMI output without HLG/L-Log and without recording to SD)					
29.97 fps	8K 4:2:0 / 8 bit	h.265	L-GOP	300 Mbps	
25.00 fps	8K 4:2:0 / 8 bit	h.265	L-GOP	300 Mbps	

24.00 fps	8K 4:2:0 / 8 bit	h.265	L-GOP	300 Mbps	
23.98 fps	8K 4:2:0 / 8 bit	h.265	L-GOP	300 Mbps	
MOV 8K (HDMI output with HLG/L-Log or during recording to SD)					
29.97 fps	4K 4:2:2 / 10 bit	h.265	L-GOP	300 Mbps	
25.00 fps	4K 4:2:2 / 10 bit	h.265	L-GOP	300 Mbps	
24.00 fps	4K 4:2:2 / 10 bit	h.265	L-GOP	300 Mbps	
23.98 fps	4K 4:2:2 / 10 bit	h.265	L-GOP	300 Mbps	
<b>MOV C4K</b>					
59.94 fps	4:2:2 / 10 bit (SD & HDMI)	h.264	ALL-I	600 Mbps	
50.00 fps	4:2:2 / 10 bit (SD & HDMI)	h.264	ALL-I	600 Mbps	
48.00 fps	4:2:2 / 10 bit (SD)	h.264	ALL-I	600 Mbps	
24.00 fps	4:2:2 / 10 bit (HDMI)				
47.95 fps	4:2:2 / 10 bit (SD)	h.264	ALL-I	600 Mbps	
23.98 fps	4:2:2 / 10 bit (HDMI)				
29.97 fps	4:2:2 / 10 bit (SD & HDMI)	h.264	ALL-I	400 Mbps	
25.00 fps	4:2:2 / 10 bit (SD & HDMI)	h.264	ALL-I	400 Mbps	
24.00 fps	4:2:2 / 10 bit (SD & HDMI)	h.264	ALL-I	400 Mbps	
23.98 fps	4:2:2 / 10 bit (SD & HDMI)	h.264	ALL-I	400 Mbps	
<b>MOV 4K</b>					
59.94 fps	4:2:2 / 10 bit (SD & HDMI)	h.264	ALL-I	600 Mbps	
50.00 fps	4:2:2 / 10 bit (SD & HDMI)	h.264	ALL-I	600 Mbps	
48.00 fps	4:2:2 / 10 bit (SD)	h.264	ALL-I	600 Mbps	
24.00 fps	4:2:2 / 10 bit (HDMI)				
47.95 fps	4:2:2 / 10 bit (SD)	h.264	ALL-I	600 Mbps	
23.98 fps	4:2:2 / 10 bit (HDMI)				
29.97 fps	4:2:2 / 10 bit (SD & HDMI)	h.264	ALL-I	400 Mbps	
25.00 fps	4:2:2 / 10 bit (SD & HDMI)	h.264	ALL-I	400 Mbps	
24.00 fps	4:2:2 / 10 bit (SD & HDMI)	h.264	ALL-I	400 Mbps	
23.98 fps	4:2:2 / 10 bit (SD & HDMI)	h.264	ALL-I	400 Mbps	
<b>MOV FHD</b>					
119.88 fps	4:2:2 / 10 bit (SD & HDMI)	h.264	ALL-I	400 Mbps	

100.00 fps	4:2:2 / 10 bit (SD & HDMI)	h.264	ALL-I	400 Mbps
59.94 fps	4:2:2 / 10 bit (SD & HDMI)	h.264	ALL-I	200 Mbps
50.00 fps	4:2:2 / 10 bit (SD & HDMI)	h.264	ALL-I	200 Mbps
48.00 fps	4:2:2 / 10 bit (SD)	h.264	ALL-I	200 Mbps
24.00 fps	4:2:2 / 10 bit (HDMI)			
47.95 fps	4:2:2 / 10 bit (SD)	h.264	ALL-I	200 Mbps
23.98 fps	4:2:2 / 10 bit (HDMI)			
29.97 fps	4:2:2 / 10 bit (SD & HDMI)	h.264	ALL-I	200 Mbps
25.00 fps	4:2:2 / 10 bit (SD & HDMI)	h.264	ALL-I	200 Mbps
24.00 fps	4:2:2 / 10 bit (SD & HDMI)	h.264	ALL-I	200 Mbps
23.98 fps	4:2:2 / 10 bit (SD & HDMI)	h.264	ALL-I	200 Mbps

#### MOV FHD ProRes

59.94 fps	422HQ	ProRes		454 Mbps
50.00 fps	422HQ	ProRes		378 Mbps
29.97 fps	422HQ	ProRes		227 Mbps
25.00 fps	422HQ	ProRes		189 Mbps
24.00 fps	422HQ	ProRes		182 Mbps
23.98 fps	422HQ	ProRes		181 Mbps

#### MOV FHD Slow Motion

Sensor: 119.88 fps	4:2:0 / 10 bit (SD & HDMI)	h.265	L-GOP	100 Mbps
Recording/ Playback: 29.97 fps				
Sensor: 100.00 fps	4:2:0 / 10 bit (SD & HDMI)	h.265	L-GOP	100 Mbps
Recording/ Playback: 25.00 fps				

#### MP4 8K

MP4 8K (recording to SD)				
29.97 fps	8K 4:2:0 / 10 bit	h.265	L-GOP	300 Mbps
25.00 fps	8K 4:2:0 / 10 bit	h.265	L-GOP	300 Mbps
23.98 fps	8K 4:2:0 / 10 bit	h.265	L-GOP	300 Mbps
MP4 8K (HDMI output without recording to SD)				
29.97 fps	8K 4:2:0 / 8 bit	h.265	L-GOP	300 Mbps
25.00 fps	8K 4:2:0 / 8 bit	h.265	L-GOP	300 Mbps
23.98 fps	8K 4:2:0 / 8 bit	h.265	L-GOP	300 Mbps

MP4 8K (HDMI output during recording to SD)				
29.97 fps	4K 4:2:2 / 10 bit	h.265	L-GOP	300 Mbps
25.00 fps	4K 4:2:2 / 10 bit	h.265	L-GOP	300 Mbps
23.98 fps	4K 4:2:2 / 10 bit	h.265	L-GOP	300 Mbps
MP4 4K				
59.94 fps	4:2:0 / 10 bit (SD & HDMI)	h.265	L-GOP	100 Mbps
50.00 fps	4:2:0 / 10 bit (SD & HDMI)	h.265	L-GOP	100 Mbps
29.97 fps	4:2:0 / 8 bit (SD & HDMI)	h.264	L-GOP	100 Mbps
25.00 fps	4:2:0 / 8 bit (SD & HDMI)	h.264	L-GOP	100 Mbps
23.98 fps	4:2:0 / 8 bit (SD & HDMI)	h.264	L-GOP	100 Mbps
MP4 FHD				
59.94 fps	4:2:0 / 8 bit (SD & HDMI)	h.264	L-GOP	28 Mbps
50.00 fps	4:2:0 / 8 bit (SD & HDMI)	h.264	L-GOP	28 Mbps
29.97 fps	4:2:0 / 8 bit (SD & HDMI)	h.264	L-GOP	20 Mbps
25.00 fps	4:2:0 / 8 bit (SD & HDMI)	h.264	L-GOP	20 Mbps
23.98 fps	4:2:0 / 8 bit (SD & HDMI)	h.264	L-GOP	24 Mbps

## VIEWFINDER/LCD PANEL

### Viewfinder (EVF)

Resolution: 5,760,000 dots, 120 fps, magnification: 0.79x at aspect ratio: 4:3 / 0.76x at aspect ratio: 3:2, frame coverage: 100%, exit pupil position: 20.75 mm, setting range -4/+2 dpt, with eye sensor for automatic switchover between viewfinder and LCD panel, time delay 0.005 s

### LCD panel

3" TFT LCD, approx. 1,843,200 dots, 384 ppi, aspect ratio 3:2, touch panel

## SHUTTER

### Shutter type

Mechanical central shutter or optional electronic shutter

## Shutter speeds

Mech. shutter: 60 min to 1/2000 s

Electro. shutter function: 60 s to 1/16000 s

Flash Synchronization: up to 1/2000 s

## Shutter button

Two-stage

(1st stage: Activation of the camera electronics including autofocus and exposure metering, 2nd stage: Taking the picture)

## Self-timer

Delay time: 2 s, 6 s, 12 s or 30 s

## Drive mode

Single, Continuous Shooting, Interval Shooting,

Exposure Bracketing

Continuous shooting:

Setting	Shutter type	Autofocus mode for continuous shooting
2 fps, 14 bit, AF	Mech. or electr. shutter	Automatic settings (exposure settings in operating modes P/A/S and autofocus) are implemented individually for each frame.
4 fps, 14 bit, AF		
5 fps, 12 bit, AF		
7 fps, 14 bit		
9 fps, 12 bit		
15 fps, 12 bit	Electr. shutter	Automatic settings (exposure settings in operating modes P/A/S and autofocus) are implemented for the first frame, and are then applied for each subsequent frame in the same picture series.

## FOCUSING

### Focusing range

60 cm to ∞

With macro setting: from 26.5 cm

## Focus mode

Automatic or manual

With manual setting: optional magnifying glass function (Auto Magnification) and edge marking (Focus Peaking) available as focus assist

## Autofocus system

Hybrid-AF due to combination of contrast metering, depth mapping, and phase comparison metering with AF metering points in the sensor.

## Autofocus modes

Optional storing of Intelligent AF, AFs, AFc, AF setting, optional Touch AF

## Autofocus metering methods

Field / Spot (can be shifted and scaled), Zone / Multi-Field (can be shifted), Tracking

## AF Detection

Human (Eye/Face/Body), Human (Eye/Face), Animal (Body), Animal (Eye/Body)

## Autofocus metering fields

315

## EXPOSURE

### Exposure metering

TTL (exposure metering through the lens), with working aperture

### Exposure metering methods

Spot, Center-Weighted, Highlight-Weighted, Multi-Field

### Exposure modes

Program AE mode (P)

Aperture-priority mode (A): manual aperture setting

Shutter-priority mode (S): manual shutter-speed setting

Manual (M): manual setting for shutter speed and aperture

Various fully automated variants (Scene Mode):

AUTO, Sport, Portrait, Landscape, Night Portrait, Snow/Beach, Fireworks, Candlelight, Sunset, Digiscoping

## Exposure compensation

±3 EV in 1/3 EV increments

## Automatic bracketing

3 or 5 frames, graduations between shoots up to 3 EV, in 1/3 EV increments

additional optional exposure compensation: up to ±3 EV

## ISO sensitivity range

	Photo	Video	L-Log	HLG
Auto ISO	ISO 100– ISO 100 000	ISO 100– ISO 100 000	ISO 800– ISO 200 000	
Manual	ISO 50– ISO 100 000	ISO 50– ISO 100 000		

## Dual Basis ISO settings

	Photo	Video	L-Log	HLG
Low Basis-ISO	ISO 100– ISO 560	ISO 100– ISO 560	ISO 800– ISO 2200	
High Basis-ISO	ISO 640– ISO 200.000	ISO 640– ISO 200.000	ISO 2500– ISO 200 000	

## White balance

Automatic (Auto), default (Daylight, Cloudy, Shadow, Tungsten, Flash), manual metering (Gray Card), manual color temperature settings (Color Temperature, 2000 K to 11500 K)

## FLASH EXPOSURE CONTROL

### Flash unit connector

Via the accessory shoe

### Flash sync time

↶ : 1/2000 s, slower shutter speeds available, automatic changeover to TTL linear flash mode with HSS-compatible Leica system flash units if sync time is undercut

### Flash exposure metering

Using center-weighted TTL pre-flash metering with Leica flash units (SF 26, SF 40, SF 58, SF 60, SF 64) or with system-compatible flash units, remote controlled flash SFC1

## Flash exposure compensation

SF 40: ±2 EV in 1/2 EV increments

SF 60: ±2 EV in 1/3 EV increments

## EQUIPMENT

### Microphone

Stereo

### Speaker

Mono

### WLAN

WLAN function for connecting to the Leica FOTOS app. The Leica app is available from the Apple App Store™ or the Google Play Store™.

	2.4 GHz	5 GHz	
EU/ US/ CN	IEEE802.11b/g/n: channel 1–11 (2412–2462 MHz)	Client mode: (For indoor use only) IEEE802.11a/n/ac: Channel 36–64 (5180–5320 MHz)	Access point + client mode: IEEE802.11a/n/ac: Channel 149–165 (5745–5825 MHz)
JP		Access point + client mode: (For indoor use only) IEEE802.11a/n/ac: Channel 36–48 (5180–5240 MHz)	Client mode: (For indoor use only) IEEE802.11a/n/ac: Channel 52–144 (5260–5720 MHz)
ROW		-	

Maximum output (e.i.r.p.): <14 dBm, encryption method: WLAN-compatible WPA™/WPA2™/WPA3™

### GPS

Not available everywhere due to country-specific legislation; can be added via the Leica FOTOS app. Data is written to Exif header of the picture files.

### Bluetooth

Bluetooth 5.0 LE: Channel 0–39 (2402–2480 MHz), maximum output (e.i.r.p.): 10 dBm

### Menu languages

English, German, French, Italian, Spanish, Portuguese, Russian, Japanese, Traditional Chinese, Simplified Chinese, Korean

## POWER SUPPLY

### Rechargeable battery (Leica BP-SCL6)

Lithium-ion rechargeable battery, rated voltage: 7.2 V (DC), capacity: 2200 mAh (min.), 348 shots (based on CIPA standard, **AF Detection Off**), 1436 shots (based on CIPA standard with adapted shooting cycle\*), Manufacturer: Panasonic Energy (Wuxi) Co. Ltd., Made in China

**\*Cycle 1:** Switch on, 1st shutter release after 5 s, one shot every 3 s, after 10 shots the camera is switched off (**Auto Power Off**) and switched on again after a waiting time of 5 min.

**\*Cycle 2:** Switch on, 1st shutter release after 5 s, one shot every 3 s, after 50 shots the camera is switched off (**Auto Power Off**) and switched on again after a waiting time of 5 min. These cycles are repeated alternately until the battery is empty.

### USB-C AC Adapter (Leica ACA-SCL6)

(optional)

Input: AC 100–240 V, 50/60 Hz, 0.25 A, automatic switchover; Output: DC 5 V/9 V, 3 A; Manufacturer: Salom Electric (Xiamen) Co., Ltd., Made in China

### Charger (Leica BC-SCL4)

(optional)

Input: AC 100–240 V, 50/60 Hz, 0.25 A, automatic switchover; output: DC 8.4 V 0.85 A; manufacturer: Salom Electric (Xiamen) Co., Ltd., Made in China

### USB-C DC-Coupler (Leica DC-SCL6)

(optional)

Input: DC 9 V/3 A (min.), Output: DC 9 V (with ACA-SCL6), supports USB PD 3.1, Manufacturer: Salom Electric (Xiamen) Co., Ltd., Made in China.

### Charging via USB

During operation: 9 V/3 A (min. 27 W)

With camera switched off: 5 V/1500 mA (2.5 W or greater)

### Wireless Charging

Optimal performance with 9 V chargers (10 W Charging Pad required)

### Rated values for input voltage/power

7.2 V = 2.3 A (battery), 5 V = 3.0 A / 9 V = 2.5 A (USB)

# LEICA APO-SUMMICRON 43 f/2 ASPH. LENS CUT

## LENS SYSTEM

### Number of lenses

11

### Segments

8

### Number of aspherical surfaces

7

### Position of entrance pupil

18.4 mm (in front of image level)

### Focusing range

0.27 m to  $\infty$

## FOCUSING

### Scale

Combined scale meter (m)/foot (ft)

### Smallest object field

Approx. 322x483 mm (Macro: 120x180 mm)

### Largest scale

1:13.4 (Macro 1:5)

### Aperture range

F2.0 to F16 in 1/3 EV increments

### Digital Zoom

Optionally approx. 1.4x (equivalent to 60 mm), approx. 1.7x (equivalent to 75 mm), approx. 2.0x (equivalent to 90 mm), approx. 2.8x (equivalent to 120 mm), or approx. 3.5x (equivalent to 150 mm)

### Image stabilization

Visual compensation system for photos and video recordings

### Filter thread

E49

### Lens hood

Click-on (included in the scope of delivery)

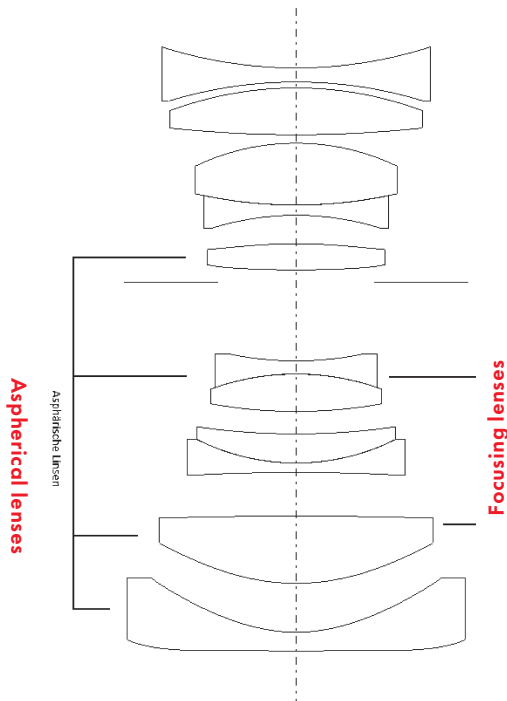

## MTF DIAGRAMS

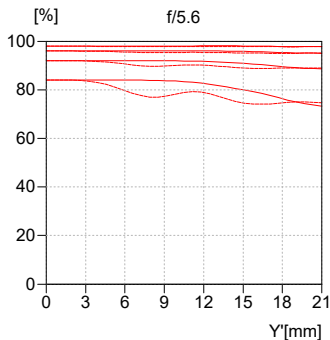
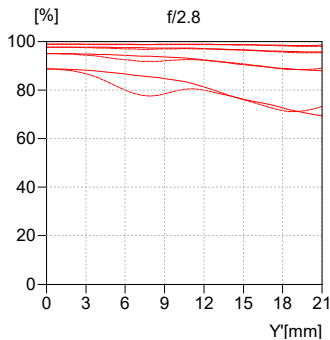
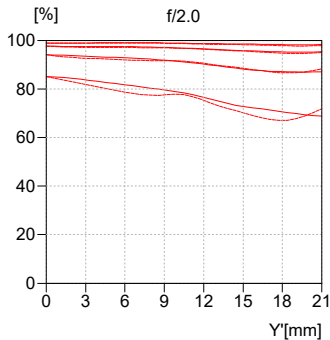

- Sagittal structures
- - - Tangential structures

The MTF is shown in each case for the max. aperture of 2.0, as well as for 2.8 and 5.6 for long focus distances (infinity). The contrast is plotted in percentages for 5, 10, 20, 40 Lp/mm over the height of the format for tangential (dashed line) and sagittal structures (continuous line) for white light. The plots for 5 and 10 Lp/mm offer an impression of the contrast behavior for coarser object structures, while the 20 and 40 Lp/mm plots document the resolution capability for fine and finest object structures.

## **LEICA HG-DC1** (optional accessory)

### **Product type**

Handgrip for contactless charging

### **Order No.**

19 530

### **Rated voltage / rated power**

9.0 V DC/1.1 A

### **Charging frequency**

110 kHz–205 kHz

### **Operating conditions**

0°C to +40°C

### **Country of origin**

China

## LEICA CUSTOMER CARE

Please contact the Customer Care department of Leica Camera AG for the maintenance of your Leica equipment and for help and advice regarding Leica products and how to order them. You can also contact the Customer Care department or the repair service provided by your regional Leica subsidiary for repairs or warranty claims.

### LEICA GERMANY

#### Leica Camera AG

Leica Customer Care  
Am Leitz-Park 5  
35578 Wetzlar  
Germany

**Phone:** +49(0)6441 2080-189

**Fax:** +49(0)6441 2080-339

**Email:** [customer.care@leica-camera.com](mailto:customer.care@leica-camera.com)

<https://leica-camera.com>

### YOUR NATIONAL REPRESENTATIVE

You will find the Customer Care department responsible for your locality on our homepage:

<https://leica-camera.com/en-US/contact>

## LEICA AKADEMIE

Have a look at our full seminar program with many interesting workshops on the topic of photography at:

<https://leica-camera.com/en-US/leica-akademie>



Leica Camera AG | Am Leitz-Park 5  
35578 WETZLAR | GERMANY  
Telephone: +49(0)6441-2080-0  
Fax: +49(0)6441-2080-333  
[www.leica-camera.com](http://www.leica-camera.com)

**Q3 43/EN/2026/6/3**